



# INDUSTRIAL PROCESS HEATING SOLUTIONS PRODUCTS AND ACCESSORIES

Volume 3



# OUR MISSION



Provide safe, reliable and innovative mission critical industrial process heating solutions that create value for our customers.

## CONTENTS

**10**

Electric Heat Tracing

**18**

Instrument Tubing Bundles

**22**

Steam Tracing And Tank/Hopper Heating

**28**

Control And Monitoring

**34**

Heat Tracing And Tubing Bundle Accessories

**38**

Cata-Dyne™ Explosion-Proof Gas Catalytic Heaters

**42**

Ruffneck™ Heaters for the Harshes Environment

**46**

Caloritech™ Engineered Electric Heat

**54**

3L Filters™ Engineered Filtration System

**61**

Norseman™ Electric Explosion-Proof Heaters

**62**

Fastrax™ Transportation Heaters

**66**

Velocity™ Transportation Heaters

**68**

Temporary Power Solutions

**80**

Training and Services

**86**

Safety



# FROM EXPLORATION TO END USERS, THERMON HAS A SOLUTION THAT IS RIGHT FOR YOU.

Thermon provides highly engineered thermal solutions for various industries, including:

- Chemical/Petrochemical
- Upstream Gas
- Midstream Gas
- Downstream Gas
- Upstream Oil
- Midstream Oil
- Downstream Oil/Refining
- Power
- Rail and Transit
- Food and Beverage
- Commercial
- Semiconductors
- Data Centers
- Renewables
- Pharmaceutical and BioTechnology
- Maritime/Shipbuilding
- Mining
- ...and More

## THERMON'S SOLUTIONS

### HEAT TRACING

Electric Heat Tracing  
 Tubing Bundles  
 Steam Tracing and Tank/Hopper Heating  
 Controls and Monitoring

### POWER SOLUTIONS

Temporary Power & Lighting

### TRANSPORTATION

Rail & Transit Heating Solutions

### HEATING SYSTEMS

**Cata-Dyne™** -  
 Explosion Proof Gas Catalytic Heaters

**Ruffneck™** -  
 Heaters for the Harshes Environment

**Norseman™** -  
 Electric Explosion-Proof Heaters

**Caloritech™** -  
 Engineered Electric Heat

**3L Filters™** -  
 Engineered Filtration Systems

**THE UNDISPUTED LEADER IN EXPERTISE AND REPUTATION, LEVERAGING A MIX OF INNOVATION AND PERSONAL SERVICE TO REVOLUTIONIZE THE PROCESS HEATING INDUSTRY.**

**UPSTREAM SECTOR**

- 1 – ONSHORE OIL AND GAS PRODUCTION
- 2 – BITUMEN PRODUCTION AND PROCESSING
- 3 – COAL-BED METHANE
- 4 – OFFSHORE OIL AND GAS PRODUCTION

**MIDSTREAM SECTOR**

- 5 – LNG LIQUIFICATION
- 6 – LNG RECEIVING TERMINAL
- 7 – LNG STORAGE
- 8 – FUEL STORAGE
- 9 – TRANSMISSION PIPELINE

**DOWNSTREAM SECTOR**

- 10 – HYDRO TREATING
- 11 – ALKYLATION PLANT
- 12 – COKING UNIT
- 13 – CONTINUOUS CATALYTIC REFORMING
- 14 – SULFUR RECOVERY
- 15 – CRUDE OIL DISTILLATION
- 16 – FLUID CATALYTIC CRACKING
- 17 – HYDROGEN PLANT
- 18 – HYDRO CRACKING

**CHEMICAL**

- 19 – CHEMICAL PROCESSING
- 20 – FERTILIZER PLANT
- 21 – PHARMACEUTICAL
- 22 – FOOD PROCESSING

**POWER GENERATION**

- 23 – COMBINED CYCLE POWER
- 24 – NUCLEAR POWER
- 25 – CONCENTRATED SOLAR POWER
- 26 – WIND POWER

**RAIL AND TRANSIT**

- 27 – TRAIN SWITCHING
- 28 – COMMUTER TRAIN

**COMMERCIAL**

- 29 – WASTE WATER TREATMENT
- 30 – HOT WATER TEMPERATURE

**INDUSTRIAL**

- 31 – TEXTILES
- 32 – PULP AND PAPER
- 33 – MINING APPLICATION

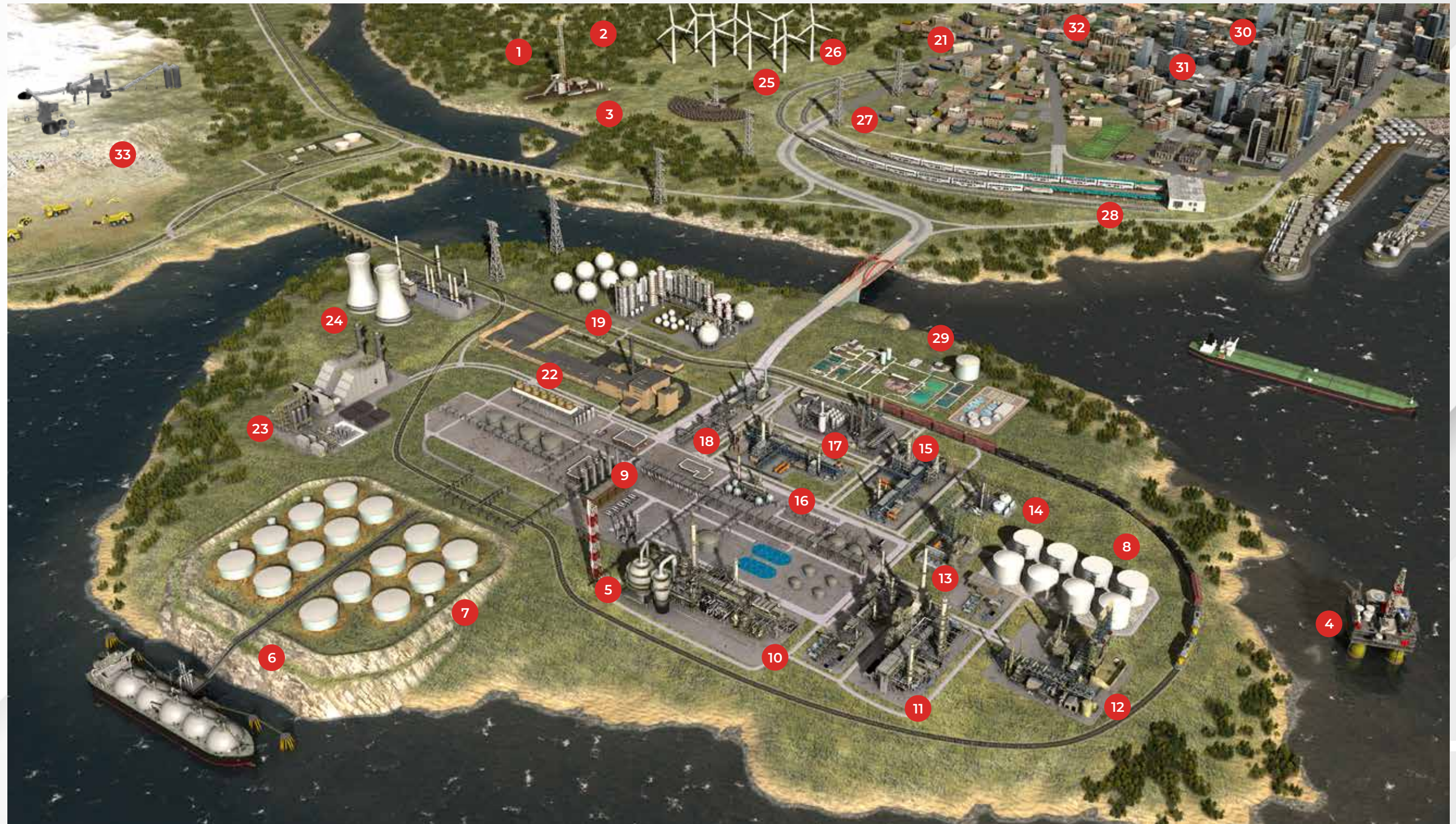

# PROCESS INDUSTRIES SERVED

*Through our global network, Thermon provides highly engineered thermal solutions.*

Thermon is the leading single-source provider of industrial process heating, delivering comprehensive, engineered solutions for complex projects, including hazardous area applications.

Since 1954, we've led the industry in designing a full spectrum of custom services that address every essential process heating requirement, from beginning to end.



### ELECTRIC HEATING

- Heat Trace
- Immersion Heaters
- Process Heaters
- Environmental - Air & Space Heaters
- Tubing Bundles
- Controls and Monitoring
- System Accessories
- Tank Heating
- Thermostats
- Band, Strip & Tubular Heaters
- Boilers & Calorifiers



### SPECIALTY PRODUCTS

- Transportation
- Engineered Products
- Control Panels
- CEMS & Analytical Systems
- Filtration Systems
- Temporary Power Systems
- Commercial



### STEAM HEATING

- Steam Trace
- Tank Heating
- Steam Heated Bundles
- Steam Supply & Return
- Heat Transfer Compounds
- Steam Trace Accessories
- Environmental - Air & Space Heaters

### GAS HEATING

- Enclosure Heaters
- Explosion Proof Gas Catalytic Heaters
- Gas Fired Blowers
- Gas Heating Accessories

# PROCESS HEATING SOLUTIONS

Thermon's solutions provide complete heating and flow assurance in the industrial and hazardous area applications.

# HEAT TRACING ELECTRIC HEAT TRACING

## SELF-REGULATING HEAT TRACING



### BSX™

- Freeze Protection and Temperature Maintenance to 65°C (150°F)
- Maximum Exposure Temperature: 85°C (185°F)
- Available Watt Densities: 10, 16, 26, 33 W/m @ 10°C (3, 5, 8 & 10 W/ft @ 50°F)
- Available Voltages: 110–120 or 208–277 V
- Available With Fluoropolymer Overjacket (FOJ)



### HTSX™

- Freeze Protection and Temperature Maintenance up to 150°C (302°F)
- Maximum Exposure Temperature up to 250°C (482°F)
- Withstands Temperatures Associated With Steam Purging
- Available Watt Densities: 10, 20, 30, 33, 39, 49, 66 W/m @ 10°C (3, 6, 9, 10, 12, 15, & 20 W/ft @ 50°F)
- Available Voltages: 110–120, 208–277 or 380–480 V



### VSX™ -HT

- Freeze Protection and Temperature Maintenance up to 200°C (392°F)
- Maximum Exposure Temperature: 250°C (482°F)
- Withstands Temperatures Associated with Steam Purging
- Available Watt Densities: 16, 33, 49, 66 W/m @ 10°C (5, 10, 15, & 20 W/ft @ 50°F)



### USX™

- Freeze Protection and Temperature Maintenance to 240°C (464°F)
- Maximum Exposure Temperature: 250°C (482°F)
- Withstands Temperatures Associated With Steam Purging
- Available Watt Densities: 10, 20, 30, 39, 49, 66 W/m @ 10°C (3, 6, 9, 12, 15, & 20 W/ft @ 50°F)
- Available Voltages: 110–120 or 208–277 V

### FEATURES:

- Semiconductive Self-Regulating Heating Matrix
- Cut-to-Length Parallel Circuitry
- Nickel-Plated Copper Bus Wires
- Metallic Braid for Grounding Purposes

- Polyolefin or Fluoropolymer Overjacket
- Unique Monolithic Co-Extrusion Processing of HTSX, VSX-HT, and USX for Optimal Performance
- Worldwide Approvals

## POWER-LIMITING HEAT TRACING

### HPT™

- Freeze Protection and Temperature Maintenance up to 210°C (410°F)
- Maximum Exposure Temperature: 260°C (500°F)
- Available Watt Densities: 16, 33, 49, 66 W/m @ 10°C (5, 10, 15 & 20 W/ft @ 50°F)
- Available Voltages \* : 120 240, and 480 V Nominal

### FEATURES:

- PTC Coiled Resistive Alloy Heating Element
- Cut-to-Length Parallel Circuitry
- Nickel-Plated Copper Bus Wires
- Metallic Braid for Grounding Purposes
- Fluoropolymer Overjacket
- Worldwide Approvals

\* Additional voltages are available; contact Thermon



## HEAT TRACING ELECTRIC HEAT TRACING

### CONSTANT WATT HEAT TRACING

#### FP™

- Freeze Protection and Temperature Maintenance to 65°C (150°F) and Foundation Heating
- Maximum Exposure Temperature: 204°C (400°F)
- Available Watt Densities: 8, 16, 33 W/m @ 10°C (2.5, 5 & 10 W/ft 50°F)
- Available Voltages: 120, 240, 480 and 575 V

#### FEATURES:

- Nichrome Heating Element
- Cut-to-Length Parallel Circuitry
- 12 AWG Copper Bus Wires
- Metallic Braid for Grounding Purposes
- Fluoropolymer Overjacket
- Worldwide Approvals



### SERIES RESISTANCE HEAT TRACING

#### FEATURES:

- Circuit Lengths up to 3660 m (12,000 ft)
- Metallic Braid for Grounding Purposes
- Fluoropolymer Overjacket
- Available with 2 or 3 conductors
- Worldwide Approvals

#### TEK™ & HTEK™

- Freeze Protection and Temperature Maintenance up to 204°C (400°F)
- Maximum Exposure Temperature up to 260°C (500°F)
- Available Watt Densities: Designs up to 65 W/m (20 W/ft)
- Available Voltages: Rated up to 600 V

#### TESH™

- Long Line Freeze Protection and Temperature Maintenance
- Maximum Exposure Temperature: 260°C (500°F)
- Available Watt Densities: Designs up to 25 W/m
- Available Voltages: Rated up to 750 Vac

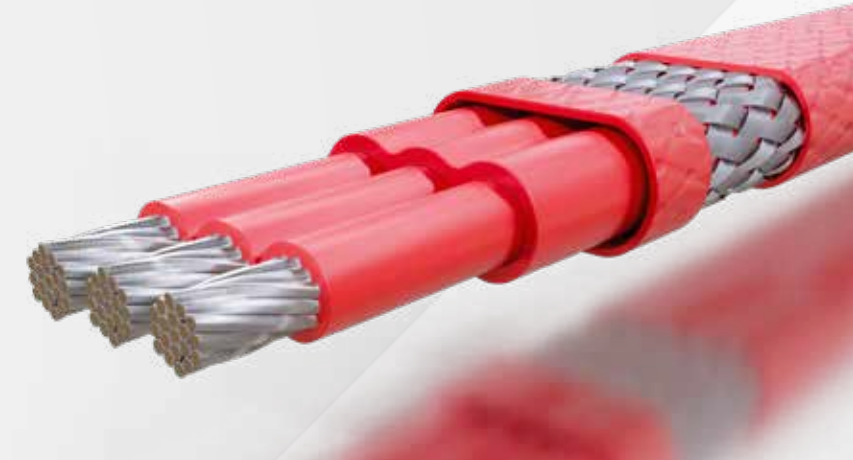

### MINERAL INSULATED HEAT TRACING

#### MIQ™

- Freeze Protection and Temperature Maintenance to 500°C (932°F)
- Maximum Exposure Temperature: 600°C (1,112°F)
- Available Watt Densities: Designs up to 262 W/m (80 W/ft)
- Available Voltages: Rated up to 600 V

#### FEATURES:

- High Temperature Magnesium Oxide Dielectric
- Seamless Alloy 825 Sheath
- Worldwide Approvals



### SKIN EFFECT HEATING SYSTEMS

#### ThermTrac™

- Freeze Protection and Temperature Maintenance to 200°C (392°F)
- Maximum Exposure Temperature: 260°C (500°F)
- Power Outputs: up to 165 W/m (50 W/ft)
- Operating Voltages: up to 5 kV

#### FEATURES:

- Circuit Lengths up to 24 Kilometers (15 Miles)
- Nickel-Plated Copper Bus Wires
- Rugged Heat Tube to Generate Heat
- Available Scuff Jacket
- Worldwide Approvals



## HEAT TRACING COMMERCIAL HEATING PRODUCTS

Thermon offers a complete range of heat tracing products and services for the commercial construction market. Whether freeze protecting pipes, melting snow or ice on roofs and outdoor surfaces, protecting freezer floors or maintaining temperatures on hot water supply lines, Thermon has your commercial heating solution.

### Piping Freeze Protection and Freezer Floor Frost Heave Prevention Applications

#### DLX™ Self-Regulating Heat Tracing

DLX protects small and medium diameter pipes from rupture and leakage caused by freezing conditions in light industrial and commercial applications. Parallel circuitry allows DLX to be cut to suit any length required in the field. Flexible materials and small cross-section provide an excellent bending radius for wrapping around complex geometries. The heat output of DLX varies along the length of the traced equipment or surface, providing the optimal heating for colder or warmer spots. As the temperature drops, heat output increases. Conversely, when the temperature increases, heat output decreases. DLX self-regulates to prevent overheating, even when overlapped. Trace heaters are CE marked for ordinary (non-classified) areas.

Built with proven and proprietary compounding, extrusion, and cross-linking technology, DLX allows for continuous operation and extended life expectancy.

- Self-regulating heat output
- Rugged and reliable
- Easy to design
- Easy to install
- Excellent for use on metallic and nonmetallic piping
- Available Watt Densities: 9, 18 W/m at 10°C (3, 5 W/ft @ 50°F)
- Nominal Supply Voltage: 230 V



DLX

#### FLX™ Self-Regulating Heat Tracing

While an insulated pipe can withstand cold temperatures longer than an uninsulated pipe, eventually the contents of the pipe will cool to the temperature of the surrounding environment. FLX™ is designed to provide freeze protection of metallic and nonmetallic pipes, tanks and equipment by replacing the heat lost through the thermal insulation into the air.

When run in conduit in the substrate, provide frost heave protection by maintaining the ground temperature above freezing. FLX varies heat output to compensate for the surrounding conditions. This self-regulating feature occurs along the entire length of a heat tracing circuit to ensure each point receives the required amount of heat while conserving energy.



FLX

- Self-regulating heat output
- Rugged and reliable
- Easy to design
- Easy to install
- Excellent for use on metallic and nonmetallic piping
- Available Watt Densities: 10, 16, 26, 33 W/m @ 10°C (3, 5, 8 & 10 W/ft @ 50°F)
- Available Voltages: 110–120 or 208–277 V



### Hot Water Temperature Maintenance Applications

#### HSX® Self-Regulating Heat Tracing

Thermon's HSX maintains hot water at desired nominal temperatures without the need for costly recirculation systems. Energy savings can be realized due to elimination of recirculated water that requires continuous reheating.

- Reliable, self-regulating performance
- Saves water and energy
- Simplified design and installation
- Hot water temperatures are maintained without the need for thermostats



HSX 2105

- Nominal Maintain Temperature: 41°C (105°F)
- Nominal Voltage: 208 V



HSX 2120

- Nominal Maintain Temperature: 49°C (120°F)
- Nominal Voltage: 208 V



HSX 2140

- Nominal Maintain Temperature: 60°C (140°F)
- Nominal Voltage: 208 V



## HEAT TRACING COMMERCIAL HEATING PRODUCTS

### Snow and Ice Melting Applications

#### SnoTrace™ RGS™ Self-Regulating Heat Tracing

Avoid the possibility of property damage and ensure a safe environment with Thermon's RGS self-regulating electric heat tracing. Designed and approved specifically for roof and gutter applications, RGS withstands direct exposure to harsh environmental conditions.

- Self-regulating performance means increased power output when needed, when snow or ice is present, and decreased power output when exposed to dry air
- Simple installation using ordinary hand tools, roof fasteners and hangers for gutters and downspouts



RGS

#### SnoTrace™ KSR™ Self-Regulating Heat Tracing

Self-regulating heat tracing has become the industry standard for snow and ice melting systems. Thermon's KSR is high performance heat tracing with cut-to-length parallel circuitry, easily adapted to variations in design found at the job site. KSR is specifically designed for direct burial in concrete and can even withstand the higher temperatures found with asphalt installations.

- Flexible and simple to design for stairs and complex layouts
- Durable construction designed for long-term operation



#### SnoTrac™ System for Surface Snow and Ice Melting

Based on skin effect heating technology, SnoTrac systems utilize a rugged, thick-walled ferromagnetic "heat tube" to melt snow and ice. This heat tube, embedded directly in concrete or asphalt, utilizes a custom designed SnoTrac conductor to safely deliver energy into the system. A truly unique feature of SnoTrac systems are their ability to provide snow melting to extremely large areas with a minimal number of circuits.

- Over 186 m<sup>2</sup> (2,000 ft<sup>2</sup>) can be protected from a single power point
- Lower energy costs than hydronic systems



## HEAT TRACING INSTRUMENT TUBING BUNDLES

### ELECTRICALLY HEATED INSTRUMENT TUBING FOR FREEZE PROTECTION AND TEMPERATURE MAINTENANCE

#### TubeTrace® Type SE/ME

Approved for hazardous (classified) locations, including options for Class I, Division 1 or Zone 1.

#### TubeTrace with HTSX™ Self-Regulating Heat Trace

- Use where temperature exposure to steam purge is expected
- Tube Temperature Range: 5°C to 150°C (40°F to 302°F)
- Maximum Exposure Temperature<sup>1</sup>: 250°C (482°F)

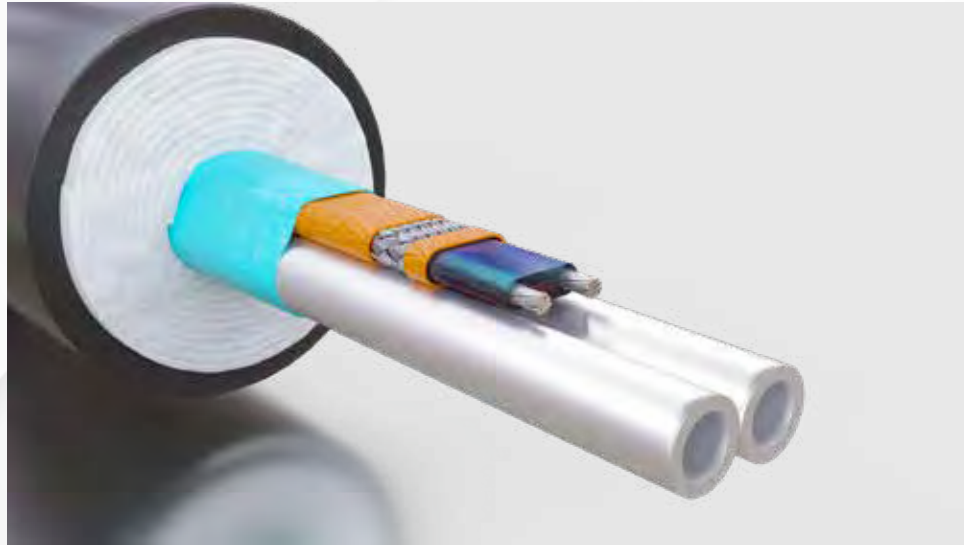

#### TubeTrace with VSX-HT™ Self-Regulating Heat Trace

- Use where high temperature exposure is a consideration.
- Tube Temperature Range: 5°C to 200°C (40°F to 392°F)
- Maximum Exposure Temperature<sup>1</sup>: 250°C (482°F)

#### TubeTrace with HPT™ Power-Limiting Heat Trace

- A “cut-to-length” heat tracing for higher temperature maintenance. Also used for freeze protection where high temperature exposure is a factor. HPT represents the best choice for maintaining temperatures up to 204°C (400°F) that can be “cut-to-length” in the field.
- Tube Temperature Range: 5°C to 204°C (40°F to 400°F)
- Maximum Exposure Temperature<sup>1</sup>: 260°C (500°F)



#### TubeTrace with BSX™ Self-Regulating Heat Trace

- Use for water freeze protection and low temperature maintenance.
- Tube Temperature Range: 5°C to 65°C (40°F to 150°F)
- Maximum Exposure Temperature<sup>1</sup>: 85°C (185°F)

### CUSTOM CEMS AND ANALYZER BUNDLES

Many analyzer applications have specialty tubing requirements, all of which Thermon can provide within our instrument tubing bundles. Examples of tube materials and finishes available include:

- Fluoropolymer tubing, 316 and 304 stainless, welded or seamless, Monel, Titanium, Inconel 825, and Alloy 20.
- Optional Electropolished (EP), Chemical Passivation (CP), and performance coatings such as SilcoNert2000 are also available on stainless steel tubing.
- Multiple tube materials can be provided in a common bundle.

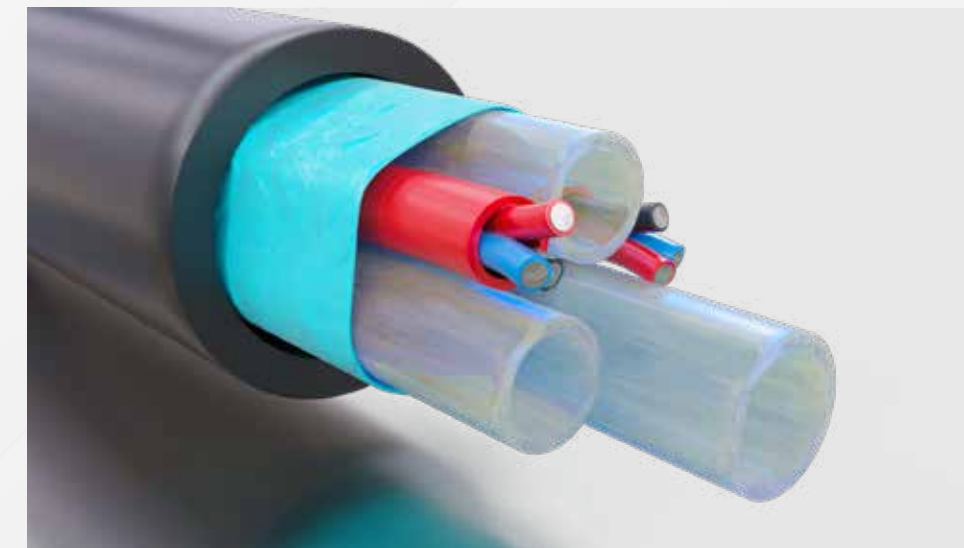

#### “NI” Non-Insulated (and Non-Heated) Bundle and Other TubeTrace Options Can Include:

- Auxiliary Conductors
- Unheated Tubes
- Factory Installed Temperature Sensor(s)
- Special Markings And Identification As Required

Notes:

1. Reflects maximum exposure temperature of heater.
2. Monel and Inconel are trademarks of Special Metals Corporation, Inc. Trade name of SilcoTek™, formerly a division of Restek Performance Coatings. SilcoNert™ 1000 replaces Silcosteel®. SilcoNert™ 2000 replaces Sulfinert®/Siltek®.

## HEAT TRACING INSTRUMENT TUBING BUNDLES

### ELECTRICALLY HEATED INSTRUMENT TUBING FOR FREEZE PROTECTION OF HIGH TEMPERATURE STEAM LINES

Isolated “cut-to-length” heat trace for high temperature exposure, suitable for ambient sensing control.

#### TubeTrace® Type SEI/MEI - HT

- Maintain: 5°C (40°F)
- Continuous Exposure: 399°C (750°F)

#### TubeTrace® Type SEI/MEI - HTX

- Maintain: 5°C (40°F)
- Continuous Exposure: 593°C (1100°F)

#### TubeTrace® Type SEI/MEI - HTX2

- Maintain: 5°C (40°F)
- Intermittent Exposure: 593°C (1100°F)



### STEAM OR FLUID HEATED INSTRUMENT TUBING FOR FREEZE PROTECTION AND TEMPERATURE MAINTENANCE



#### Steam or Fluid “Light Traced” (SI/MI)

- For freeze protection and lower temperature maintenance. The tracer tube is isolated from the process tube(s), so process tube temperatures will be significantly lower than the tracer tube temperature.
- Tube Temperature Range: 5°C to 121°C (40°F to 250°F)
- Maximum Exposure: 205°C (400°F) \*



#### Steam or Fluid “Heavy Traced” (SP/MP)

- For freeze protection and process maintenance. The tracer tube is in direct contact with the process tube(s), so process tube temperatures will be very close to the tracer tube temperature.
- Standard Tracer Temperature Range: 5°C to 205°C (40°F to 400°F)
- Maximum Exposure: 205°C (400°F) \*

\* Higher tube temperatures are possible with XINS-extra installation, HT and HTX type designs.

## HEAT TRACING STEAM TRACING AND TANK/HOPPER HEATING

### HEAT TRANSFER COMPOUNDS TO MAINTAIN HIGH TEMPERATURES

#### “Thermonized” With Thermon Heat Transfer Compounds

- Consistent Heat Transfer Properties
- Less Than 20% of Cost for Steam Jacketing

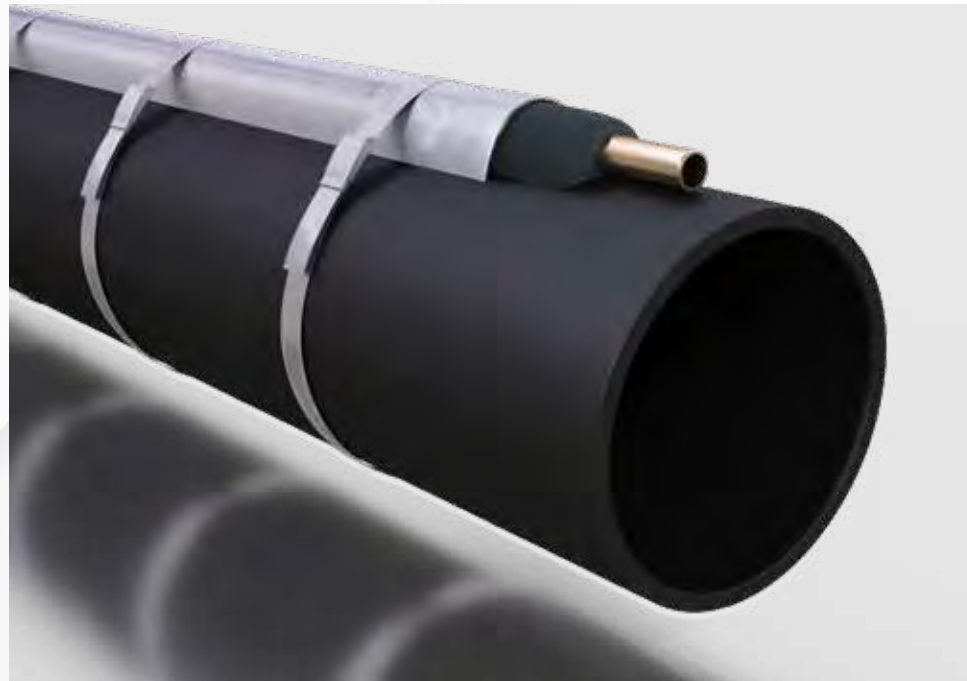

#### Snaptrace® Preformed Extrusions For Straight Piping

- Available in 1.22 m (4 ft) lengths
- Significantly Reduces Installation Time
- No Surface Preparation Required
- Use With Up to 232°C (450°F) Fluid/Steam

#### HT Compounds for Piping, Valves & Irregular Surfaces (Maximum temperature ratings shown)

- T-3: 454°C (850°F)
- T-99: 1204°C (2,200°F)
- T-85: 232°C (450°F)

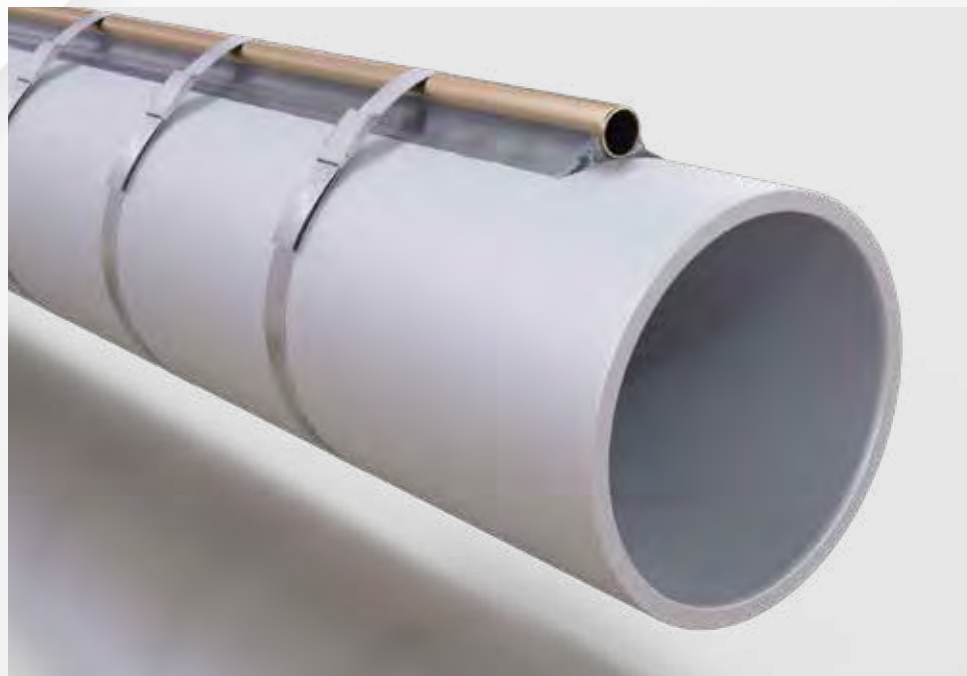

## ISOLATED STEAM TRACERS FOR LOWER MAINTAIN TEMPERATURES

#### SafeTrace™ Provides Increased Safety

- SafeTrace Tracers Comply With Tests for Skin Exposure (per ASTM Std C-1005/1057)
- Safety Yellow Jacket Alerts Plant Personnel to Potentially Dangerous Conditions

#### SafeTrace™ Provides Predictable Heat Transfer

- Permits Winterization for Any Size Pipe
- Eliminates Hot/Cold Spots Associated With Bare Tubing and Spacer Blocks
- Suitable for Temperature-Sensitive Processes

#### Medium Maintain Temperatures

- SafeTrace™ BTS: 38°C to 121°C (100°F to 250°F)



**SafeTrace™ SLS-IT:**  
24°C to 93°C (75°F to 200°F)

**SafeTrace™ DLS-IT:**  
5°C to 54°C (40°F to 130°F)

## STEAM SUPPLY/CONDENSATE RETURN LINES

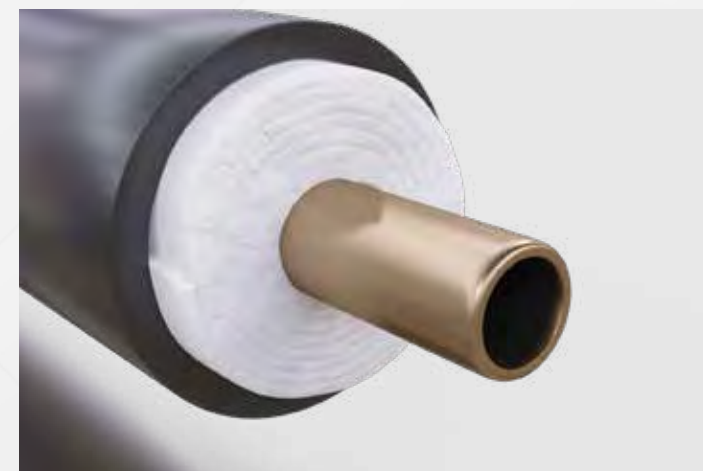

#### ThermoTube® Pre-Insulated Tubing

- Ideally Suited to Transport Liquids, Gases or Refrigerants
- Non-hygroscopic Glass Fiber Insulation for Efficiency
- Protective Outer Jacket Resists Weather and Moisture
- ThermoTube Can be Installed in Cable Trays, Angles, Channels, Struts and on I-Beams
- All Tubing Types Available
- Continuous Temperature Range: Service to 205°C (400°F) \*
- ThermoTube ratings to 593°C (1100°F) also available \*

\* Higher tube temperatures are possible with XINS-extra insulation HT and HTX type designs. For steam heated instrument tubing, see Instrument Tubing Bundles.

## HEAT TRACING STEAM TRACING AND TANK/HOPPER HEATING

### TANK AND VESSEL HEATING

#### RT FlexiPanel® & RTF FlexiPanel® Tank and Vessel Heating Units

- High Temperature Lead Wires (16 AWG)
- Protective Metal Jacket
- Parallel Circuit High Temperature Alloy Heating Element
- Heat-Laminated, High Temperature Silicone Rubber Insulation
- Nominal Output:
  - RT FlexiPanel 500, 1,000, and 2,000 W
  - RTF FlexiPanel 300 and 500 W
- Supply Voltage: 120 or 240 V
- Temperature Maintenance to: 121°C (250°F)
- Maximum Exposure Temperature: 232°C (450°F)



#### HeetSheet® Tank and Vessel Heating Units

- Provides Predictable and Reliable Heating (or Cooling)
- Factory-Applied Non-Hardening Heat Transfer Compound Ensures Maximum Heat Transfer
- Waffle Pattern Permits Multiple Flow Paths for Heating and Cooling Media
- Provides 2 to 3 Times the Heat Transfer of Plate-Type Coils
- No Risk of Cross-Contamination with Process
- Lightweight Stainless Steel Construction for Easy Installation
- Stainless Steel Inlet and Outlet Tubing Provided from Factory



### HOPPER AND CHUTE HEATING

#### HT Module Hopper Heater

- Fluoropolymer Insulated High Temperature 16 AWG Lead Wires (with stress relief at connection)
- Parallel Circuit High Temperature Alloy Heating Element
- Temperature-Rated Insulation (directs energy towards surface to be heated)
- Aluminized Steel Protective Enclosure and Cover
- Temperature Maintenance up to 427°C (800°F)
- Maximum Exposure Temperature: 538°C (1000°F)
- Maximum Watt Density: 4,650 W/m<sup>2</sup> (3 W/in<sup>2</sup>)
- Supply Voltages: 120–600 V



## HEAT TRACING HEAT TRANSFER COMPOUND

### HEAT TRANSFER COMPOUND T-3

- T-3: 371°C (700°F)

T-3 heat transfer compound now has higher temperature ratings

than ever before while still creating an efficient thermal bond between a steam or electric heater and process pipes or equipment. A single "Thermonized™" steam tracer utilizing Thermon's heat transfer compound is more cost effective than a contoured clamp-on jacket and has the equivalent performance of three to five bare tracers.

The new and improved T-3 now boasts maximum exposure temperature ratings of 371°C (700°F). To minimize waste and speed installation, use Thermon's ChannelTrace™ system featuring TFK channels. The ChannelTrace system provides protection prior to installation of thermal insulation and eliminates special curing procedure for the new and improved T-3 heat transfer compound.



# HEAT TRACING TECHNOLOGY AND SOFTWARE SOLUTIONS

Industry leading solution to your heat tracing challenge



## Project and Document Management

- Revision control and repository for customer document exchange
- Electronic submission and approval with workflow automation
- Identifies who must take next action, and bottlenecks
- Generates and manages RFIs (including attachments)
- Customer dashboard and reporting

## Genesis Controller

- Smart and connected controllers that put Thermon's expertise at your fingertips
- Displays heat trace ISO drawings and historical data for rapid troubleshooting
- Configured directly from the design database by TraceNet Sync without manual data entry or errors
- High-tech and intuitive user interface based on familiar touch technology
- Fully connected via Industrial Internet of Things (IIOT) networking to the control room or any network location
- Easy updates with new software features and customer value with the click of a button



- > Heat Trace ISOs
- > Panel Settings
- > Software Updates

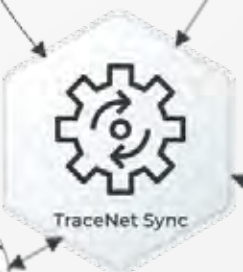

## TraceNet Sync

- Design drawings and panel settings are digitally packaged for panel commissioning
- Settings and drawings are pulled directly from project design database
- Services team quickly and easily installs the package
- Reduces time at panel, eliminating chances for errors
- Ensures operational as-built panels match the design drawings and settings

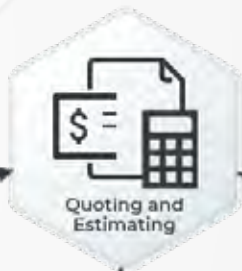

- > Navisworks File
- > SmartPlant Review
- > IDF/PCF
- > Drawings
- > Line List
- > P&IDs

## Quoting and Estimating

- Offers an optimal project quote that meets specifications
- Thermon team often has experience with your specs which speeds response and accuracy
- Software automation reduces need for estimation
- Leverages heat trace design calculations for quoting

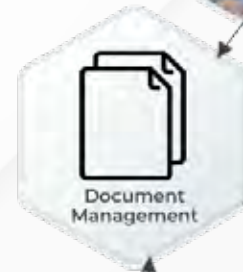

## Data Intake

- Thermon is FLEXIBLE and can receive data in many forms
- Direct digital outputs from the plant model (Navisworks/PCF/IDF) are preferred and most efficient, accurate, and cost effective
- Changes are expected—revision changes are quickly identified.



## CompuTrace Power Management (CPM)

- Optimally assigns loads to panels, power phases, and substations
- Balances panel loads and phase loads
- Shortest distance calculations from heater to panel and panel to substation.
- Automatically generate panel schedules and layout drawings
- Synced via database in real-time with heat trace designers



## VisiTrace 3D

- Designers work in imported 3D piping model
- Visually and optimally select pipe for trace heating
- Automatically creates heat trace isometric drawings
- Bills-of-materials added automatically from CompuTrace
- A Thermon expert designer can create an ISO in minutes

## CompuTrace

- Automatically calculates heat transfer and loss
- Multi-segment design support
- Optimizing calculations based on extensive product and field data
- Design requirements and max temperature constraints are assured
- Calculates optimal solution and complete bill-of-materials
- Reviewed, adjusted and approved by Thermon design experts
- Decades of heat trace design experience captured in software

## HEAT TRACING CONTROL AND MONITORING

### THE GENESIS NETWORK

The Thermon **Genesis Network** consists of a control room server, a gateway, and a collection of field deployed bridges/nodes that form a wireless mesh communications network. Alternatively, the network can be made via a traditional wired Ethernet network. The **Genesis Network** connects all heat trace panels and controllers to the control room and gives visibility of all assets from a single dashboard and user interface that can be accessed from any browser.

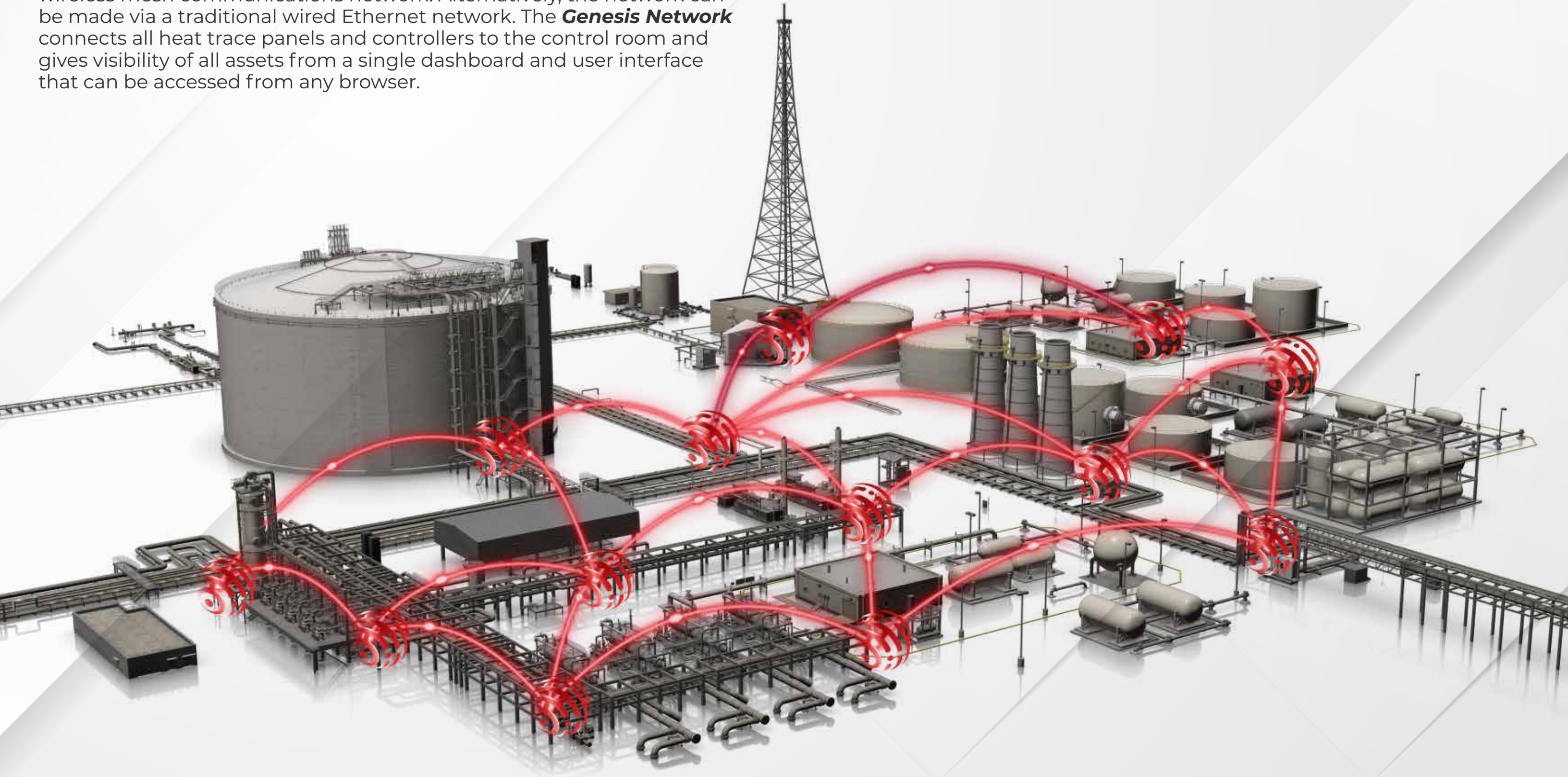

## HEAT TRACING CONTROL AND MONITORING

### GENESIS DUO

Thermon's innovative Genesis Duo is a microprocessor-based temperature and control module for heat tracing applications. The unit features a dual point IIoT enabled heat trace temperature controller and high temperature limiter that provides control and monitoring capabilities for one or two heat tracing circuits. The Duo can be configured to control and limit up to two intrinsically safe dedicated RDT inputs per circuit for the limiter channel.

Genesis Duo features a 4.3" glove touch capable LCD display with an additional light ring for visual indication. As a native product to the Genesis Network, the Genesis Duo requires no additional hardware to communicate within Thermon's state of the art supervisory and management platform.





## HEAT TRACING CONTROL AND MONITORING

### GENESIS CONTROLLER

The Genesis Controller represents a quantum leap forward in thermal control and monitoring, whether functioning as a component of the Genesis Network or as a stand-alone controller for smaller applications. Its key capabilities include:

- Glove-Touch User Interface
- Day and Night Modes
- Up to 6 months History to Aid in Troubleshooting
- ISO drawing in pdf format for viewing on Genesis HMI



### GENESIS BRIDGE

The Genesis Bridge links panels and controllers to the wireless mesh network. The Genesis Bridge is a more cost effective, flexible, and feature rich method for establishing communication when compared to traditional wired networks.

The Genesis Bridge acts as a repeater for other nodes. It dynamically adjusts to “heal” or “repair” paths within the mesh network. Industrial facilities have numerous obstacles that can interfere with wireless communications, and the Genesis Bridge provides the additional redundant wireless paths to maximize communication success.

Alternatively, bridges can communicate using a traditional wired Ethernet network.



### GENESIS SERVER

Genesis Server is industry-leading software running on a server in the control room. Genesis Server communicates with all heat trace panels and controllers in the facility, and displays and communicates alarm status and summaries. It collects performance history of the heating system including temperatures and heater current over time for analysis, reporting, and troubleshooting. Genesis Server pushes software updates to panels and controllers in the field when new features and value added improvements are released

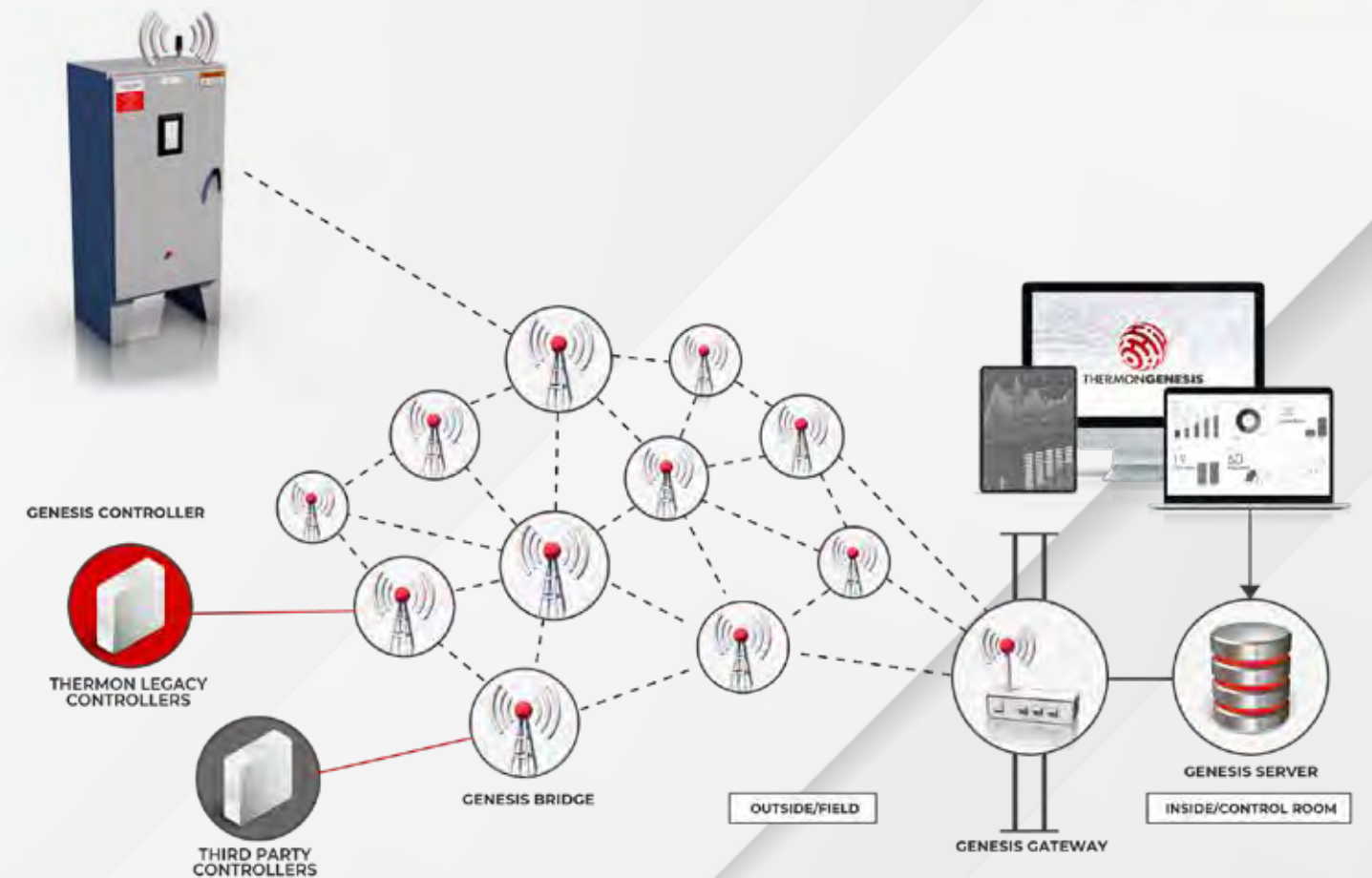

### GENESIS GATEWAY

The Genesis Gateway is the access point between the control room server and wireless mesh network in the field. It manages all communications to and from the Genesis Bridges and network nodes. The Genesis Gateway securely controls the addition and removal of any node on the network. The gateway also manages the deployment and installation of software updates for all Genesis smart devices and controllers.

## HEAT TRACING CONTROL AND MONITORING



### ELECTRONIC CONTROLLERS WITH POWER DISTRIBUTION

Pre-assembled controller skids are an integral component of Thermon's total systems approach to provide you with the most cost effective system.

Designed specifically for YOUR electrical requirements, Thermon Controller skids can include transformer(s), distribution panel, electrical heat tracing controller panel, and connection accessories. All on one convenient skid.

- Reduce site installation costs
- Pre-wiring is done in a controlled environment
- Completed assembly is delivered to your site ready for hook-up to your main power feed(s)
- Reduce RTD and power wiring costs
- Reduce maintenance and total costs of ownership
- Components are secured to a structurally designed, pre-wired skid



### LEGACY ELECTRONIC CONTROLLERS

#### TraceNet™ TCM18

- Monitor electric heat trace circuit operating and ground/earth leakage currents
- Selectable control method (On/Off, On/Off With Soft Start, Proportional, Ambient Proportional) on a per circuit basis
- Programmable alarm set points, with alarm acknowledgment and reset capability
- Programmable trip set-points for each circuit
- Temperature sensor status indication
- Unique circuit identifier
- Communication to host computer via RS4-85 serial communication.
- "Push to Test" ground/earth leakage test feature on a per circuit basis
- Ground/earth leakage interruption capability



#### TraceNet™ TCM2

- Monitor electric heat trace circuit operating and ground/earth leakage currents
- Selectable control method (On/Off, On/Off With Soft Start, Proportional, Ambient Proportional) on a per circuit basis
- Programmable alarm set points, with alarm acknowledgment and reset capability
- Programmable trip set-points for each circuit
- Temperature sensor status indication
- Communication to host computer via RS4-85 serial communication.
- "Push to Test" ground/earth leakage test feature on a per circuit basis
- Ground/earth leakage interruption capability



#### TraceNet™ ECM

- Encapsulated electronics and control
- One temperature control module for wide range of temperature control and limiter applications
- Energy saving accurate electronic temperature control action
- Data highway communication capability
- Selectable automatic or manual reset limiter action
- Control/limiter setting in degrees Centigrade or degrees Fahrenheit
- Combines power junction box and control module in one unit
- Also available as ambient thermostat (WP mount only)



# HEAT TRACING ACCESSORIES

## POWER CONNECTION KITS

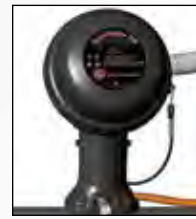

**Terminator DP and ZP** nonmetallic kits fabricate power connections of an electric heat trace circuit.



**Terminator DL and ZL** nonmetallic kits fabricate power connections and provide visual indication of an energized heat trace circuit.



**ECA-1** metallic kits fabricate power connections of an electric heat trace circuit.



**PCA** nonmetallic kits fabricate power connections of an electric heat trace circuit.

## END TERMINATION KITS



**Terminator DS/DE and ZS/ZE** nonmetallic kits fabricate an end termination of an electric heat trace circuit.



**Terminator DE-B and ZE-B** nonmetallic kits provide visual indication of an energized heat trace circuit. (Also available in red)



**PCS** nonmetallic kits fabricate an end termination of an electric heat trace circuit.

## T-SPLICE KITS



**Terminator DP and ZP** nonmetallic kits fabricate T-splice connections of an electric heat trace circuit.



**ECT-2** metallic kits are for splicing three electric trace heaters together.



**PCA** nonmetallic kits fabricate T-splice connections of an electric heat trace circuit.

## MISCELLANEOUS



**PETK** power and end termination kits are required for use with all Thermon parallel trace heater connection kits.



**SCTK** splice connection kits are required when preparing splices with all Thermon parallel trace heater connection kits.



**FT-1L, FT-1H** fixing tapes for attaching trace heater to piping every 30 cm (12") or as required.



**AL-20L, AL-20H, AL-30L, AL-30H** aluminum tape for continuous (longitudinal) covering.

## MECHANICAL THERMOSTATS



**B4X-15140 and B7-15140** provide ambient sensing control of electric heat trace circuits.

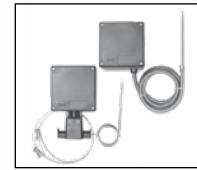

**E4X-35235 and E4X-1** provide pipewall or tankwall sensing control of electric heat trace circuits.



**E4X-25325 and E7-25325** provide pipewall or tankwall sensing control of electric heat trace circuits.



**RTD-100** is for use as control input for electric heat trace circuits requiring pipewall or tankwall temperature sensing.

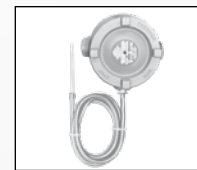

**E4X/7-35235JB, E4X/7-200600JB and 4X/7350235JB** provide pipewall or tankwall sensing control of electric heat trace circuits.

## IN-LINE SPLICE KITS



**Terminator DS/DE and ZS/ZE** nonmetallic kits fabricate in-line splices of an electric heat trace circuit.

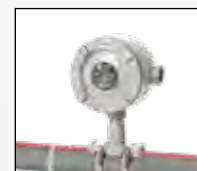

**ECA-1** metallic kits are for splicing two electric trace heaters together.



**PCS** nonmetallic kits fabricate in-line splices of an electric heat trace circuit.

## ENCLOSURE/SHELTER ENTRY KITS

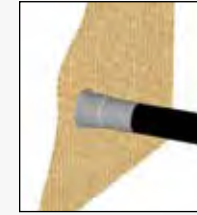

**Bulkhead Entry Heat Shrink Seal FAK-9 Series** provides an effective transition and strain relief when bundle passes through a wall 2.5 cm (1") thick or less.



**FAK-1 Kit** for bulkhead entry of TubeTrace and ThermoTube bundles. Creates waterproof seal around the bundle.



**Terminator DP/FAK-1 and ZP/FAK-1 Kits** for bulkhead entry of electrically heated TubeTrace bundles create a waterproof seal over the end of TubeTrace and terminate electric heat tracing.



**Terminator DE-B/FAK-1 and ZE-B/FAK-1 Kits** for bulkhead entry of electrically heated TubeTrace bundles create a waterproof seal over the end of TubeTrace and terminate electric heat tracing.

## T-SPLICE KITS



**T-Splice FAK-5 Kits** create a waterproof seal over TubeTrace and ThermoTube splices.



**Terminator DP/FAK-5 and ZP/FAK-5 Kits** for T-splice of electrically heated TubeTrace bundles. Creates a waterproof seal at T-splice connections of TubeTrace bundle with electric heat tracing.

## IN-LINE SPLICE KITS



**In-line Splice FAK-4 Kits** create a waterproof seal over TubeTrace and ThermoTube splices.



**Terminator DP/FAK-4 and ZP/FAK-4 Kits** for an in-line splice power connection of electrically heated TubeTrace bundles.



**Terminator DS/FAK-4 and ZS/FAK-4 Kits** fabricate outside in-line splices on insulated TubeTrace with electric heat tracing.



**FAK-8 Kits** create a waterproof seal over TubeTrace and ThermoTube splices.

## 90° ELBOW TRANSITION KITS



**90° Elbow Transition FAK-2 Kits** create a waterproof seal over TubeTrace and ThermoTube splices.



**Terminator DS/FAK-2 and ZS/FAK-2 Kits** fabricate accessible outside the insulation in-line splices or end terminations on TubeTrace with electric heat tracing.



**Terminator DP/FAK-2 and ZP/FAK-2 Kits** fabricate outside the insulation power connection, in-line splices or end terminations on TubeTrace with electric heat tracing.

## HIGH TEMPERATURE SEAL KIT



**FAK-7HTS Kits** create a seal over the end of TubeTrace and ThermoTube for high temperature applications.

## FIELD INSTALLED CONTROL SENSOR KITS



**FAK-4T Kits** provide a waterproof seal over TubeTrace for field installed thermostat.



**FAK-4S Kits** provide a waterproof seal over TubeTrace for field installed sensor.

## TERMINATION/SEAL KITS

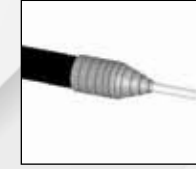

**FAK-7 Seal Kits** create a waterproof seal over the end of TubeTrace and ThermoTube.

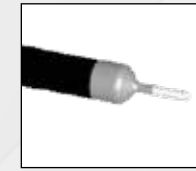

**FAK-10 Kits** create a waterproof seal over the end of TubeTrace and ThermoTube. Kits include heat shrink seal.

- Terminator "D" kits Division 2 and Zone 2 Areas
- Terminator "Z" kits Zone 1 Areas.
- Heat Trace power and end termination and splice connection kits purchased separately.



# HEATING SYSTEMS

# Cata-Dyne™

## EXPLOSION-PROOF GAS CATALYTIC HEATERS



### WX SLIMLINE INFRARED GAS CATALYTIC HEATER

#### Features:

- Offers the same industry standard performance for space or spot heating applications in hazardous environments as the WX Series, with the added convenience of a compact stainless steel cabinet only 3.8 cm (1.5") thick, making it ideal for applications with space installation constraints
- 40% greater BTU/unit area than our WX heater
- Faster startup time
- Available for either natural gas or propane fuel
- 6 available cabinet sizes; models range from 1,750 to 56,000 BTU/hr and 12 to 600 V
- FM certified for use in hazardous locations
- Available in the USA only



### MLH - MICRO LINE HEATER

#### Features:

- Micro Line Heater prevents equipment freezing and possible hydrate formation during pressure reduction at natural gas regulating sites.
- The Micro Line Heater heats the gas stream using infrared radiant heat transfer, eliminating the use of burners, glycol fluid and high maintenance heat exchange systems.
- Thermostat controls allowing for easy adjustment
- Ideal for lower flow conditions where Glycol Water Bath systems are excessive
- Designed for use in Class I, Division 2, Group D hazardous locations



### WX INFRARED GAS CATALYTIC HEATER

#### Features:

- The industry standard for space or spot heating applications in hazardous environments, including comfort heating for industrial buildings and installations, freeze protection for equipment and components, and drying or curing processes
- Models range from 1,250 to 60,000 BTU/hr and 12 to 600 V
- Available for either natural gas or propane fuel
- CSA, FM and CE/ATEX certified for use in hazardous locations
- EAC marked for Eurasian markets



### LH LINE HEATER

#### Features:

- Prevents equipment freezing and possible hydrate formation during pressure reduction at natural gas regulating sites
- Available in five standard sizes, ranging from 40,000 to 160,000 BTU/hr
- Custom engineered units for non-standard applications are available
- The heart of each LH Series line heater is the industry standard Cata-Dyne™ WX Gas Catalytic Heater. The Cata-Dyne™ WX brings its trademark quality, durability and performance efficiency to provide the most consistently reliable radiant heat source available.
- Designed for use in Class I, Division 2, Group D hazardous locations



### MKII INFRARED GAS CATALYTIC HEATER

#### Features:

- Like the WX Series, the MKII Series is an industry standard for space or spot heating applications in hazardous environments, including comfort heating for industrial buildings and installations, freeze protection for equipment and components, and drying or curing processes
- Side mounted hardware for lower installation profile
- Models range from 5,000 to 40,000 BTU/hr and 12 to 600 V
- Available for either natural gas or propane fuel
- CSA and FM certified for use in hazardous location
- EAC marked for Eurasian markets



### SS SURE SEAL™ PIPELINE SYSTEM

#### Features:

- A unique infrared heating system consisting of propane fired Cata-Dyne™ heaters (the hottest catalytic gas heater on the market) mounted in a clamshell frame configuration to provide a safe and fast method of applying heat to the construction and maintenance of pipeline systems of various sizes greater than 5 cm (2") diameter
- The large surface area of the Cata-Dyne™ heaters allows for efficient transfer of infrared heat that can be utilized in a variety of pipeline applications
- Suitable for preformed wrap around sleeves
- Ideal for both preheat and shrink sleeve processes
- Available for pipeline applications up to 122 cm (48") in diameter



# Cata-Dyne™

## EXPLOSION-PROOF GAS CATALYTIC HEATERS



### SCH - SUPER CONDUCTOR ENCLOSURE

**Features:**

- Innovative heat transfer technology using radiant heat from conducting rods to create a moisture-free heat source
- Used for applications such as providing dry penetrating heat for small enclosures that house batteries, radio controls, and other moisture-sensitive equipment
- Heating capacity ranges from 1,000 to 4,000 BTU/hr
- Available for either natural gas or propane fuel
- CSA and FM certified for use in hazardous locations

### IGP - INSTRUMENT GAS PREHEATER

**Features:**

- The preferred solution for providing the gas industry with freeze protection for instrument supply gas, pilot actuated regulators and related applications, including freeze prevention at metering sites or gas chromatographs, valves, pilots and other low flow
- Heat capacity ranges from 1,700 to 5,000 BTU/hr
- Available for either natural gas or propane fuel
- CSA and FM certified for use in hazardous locations



### HEA - REGULATOR ENCLOSURE



**Features:**

- Designed to clamp directly to the pipeline, spring clamps make installation easy
- Enclosure comes fully assembled
- Stainless steel enclosures provide added longevity for the harshest environments
- Optional thermostats and regulators are available
- Custom designed enclosure packages available upon request
- Cata-Dyne™ heaters are CSA or FM certified, available in both natural gas or propane

### CHS CATA-DYNE™ HEATING PACKAGE

**Features:**

- Automated space and spot heating for applications where flammable gases, vapors or liquids may be present
- Equipped with Cata-Dyne™ explosion-proof infrared heaters, this system comes standard or custom designed to meet any unique application
- Cata-Dyne™ infrared heaters are controlled remotely with an integrated explosion-proof control panel
- Applications include comfort heating for industrial buildings, CNG or propane vehicle maintenance facilities, and freeze protection for equipment and components



# Ruffneck™

## HEATERS FOR THE HARSHTEST ENVIRONMENTS



### AV ADVANCED VERTICAL HEAT EXCHANGER UNIT HEATER

**Features:**

- Designed for rugged industrial applications such as steam, circulating hot water, or glycol heating systems, in addition to a wide range of other heating fluids and can be used for both space heating and liquid cooling applications
- Maximum operating pressure and temperature rating of 450 psi and 343°C (650°F)
- UL and CSA certified motors; explosion-proof or general purpose
- All models are CRN registered

### RGE REGULAR-DUTY FORCED AIR UNIT HEATER

**Features:**

- Designed for use in regular-duty industrial and commercial space heating applications
- Models range from 2 to 40 kW and 208 to 600 V
- CSA C/US certified
- CE marked
- EAC marked



### CX1 PROVECTOR® CONVECTION HEATER

**Features:**

- Designed and manufactured specifically for demanding requirements and harsh operating conditions such as those in the gas well drilling industry
- Models range from 0.75 to 10.0 kW, 120 to 600 V, 1 PH, and 208 to 600 V, 3 PH. UL C/US certified for Groups A, B, C, D, IIA, IIB and IIC; IP55 moisture ingress protection available



### RGX HEAVY-DUTY FORCED AIR UNIT HEATER

**Features:**

- Specifically engineered for heavy-duty use in industrial environments
- Models range from 15 to 50 kW and 208 to 600 V
- CSA C/US certified
- CE marked
- EAC marked



### AH ADVANCED HORIZONTAL HEAT EXCHANGER UNIT HEATER

**Features:**

- Designed for rugged industrial applications and can be used with a variety of heat transfer fluids such as steam, circulating hot water, and glycol heating systems or in liquid cooling applications
- Models range from 6,000 to 1,200,000 BTU/hr and 115 to 440 V
- UL and CSA certified motors; explosion-proof or general purpose
- All models are CRN registered



### FX5 EXPLOSION-PROOF ELECTRIC AIR UNIT HEATER

**Features:**

- Designed for the harshest industrial environments including dry indoor industrial applications, drilling rigs, plant and process buildings
- Models range from 3 to 35 kW and 208 to 600 V
- UL certified for the following hazardous location classifications: Class I, Divisions 1 & 2, Groups C & D; Class II, Divisions 1 & 2, Groups E, F & G; Class I, Zones 1 & 2, Groups IIA & IIB; Temperature Code T3B 165°C (329°F)



# Ruffneck™

## HEATERS FOR THE HARSHTEST ENVIRONMENTS

### FX5-SD SEVERE DUTY ELECTRIC AIR UNIT HEATER

**Features:**

- Built for severe duty applications that can lead to accelerated wear of electrical components and damage to the heater core, including locations with fluctuating power quality, temporary power generation, high vibration, dirty or corrosive atmospheres, or extended maintenance intervals
- Models range from 3 to 35 kW and 208 to 600 V
- UL certified for the following hazardous location classifications: Class I, Divisions 1 & 2, Groups C & D; Class II, Divisions 1 & 2, Groups E, F & G; Class I, Zones 1 & 2, Group IIA & IIB; Temperature Code T3B 165°C (329°F)



### HP HIGH PRESSURE HEAT EXCHANGER UNIT HEATER

**Features:**

- Extra heavy-duty to meet the most demanding service and long life requirements for rugged industrial applications, such as space heating and liquid cooling
- Models range from 115 to 575 V; explosion-proof or general purpose
- UL and CSA certified motors
- All models are CRN registered
- EAC marked for Eurasian markets



### FR FROST-RESISTANT HEAT EXCHANGER UNIT HEATER

**Features:**

- Specifically designed for steam applications that may be subject to freezing conditions, and of particular value for outdoor applications
- Models range from 115 to 575 V; explosion-proof or general purpose
- UL and CSA certified motors
- All models are CRN registered
- EAC marked for Eurasian markets



### CRI TRITON™ CORROSION-RESISTANT WASHDOWN HEATERS

**Features:**

- A new generation of NEMA 4X corrosion-resistant washdown heaters
- Entire heater is NEMA Type 4X
- Epoxy coated fan blade
- 16-gauge stainless-steel cabinet
- Custom configured stainless-steel elements
- Optional built-in accessories
- Stainless-steel wall/ceiling mounting kit
- 120 V controls
- Stainless-steel temperature high-limit
- Available in a wide range of wattages, from 3 to 39 kW





# Ruffneck™

## HEATERS FOR THE HARSHTEST ENVIRONMENTS

### FX6 EXPLOSION-PROOF ELECTRIC AIR UNIT HEATER

#### Features:

- Designed for the harshest industrial environments including dry indoor industrial applications, drilling rigs, plant and process buildings
- Models range from 3 to 35 kW and 208 to 600 V
- Two levels of over temperature protection with dedicated contactor, standard on all FX6 heaters
- UL certified for the following hazardous location classifications: Class I, Divisions 1 & 2, Groups C & D; Class II, Divisions 1 & 2, Groups E, F & G; Class I, Zones 1 & 2, Groups IIA & IIB; Temperature Code T3B 165°C (329°F)



### FX6-SD SEVERE DUTY ELECTRIC AIR UNIT HEATER

#### Features:

- Built for severe duty applications that can lead to accelerated wear of the electrical components and damage to the heater core, including locations with fluctuating power quality, temporary power generation, high vibration, dirty or corrosive atmospheres or extended maintenance intervals
- Models range from 3 to 35 kW and 208 to 600 V
- UL certified for the following hazardous location classifications: Class I, Divisions 1 & 2, Groups C & D; Class II, Divisions 1 & 2, Groups E, F & G; Class I, Zones 1 & 2, Group IIA & IIB; Temperature Code T3B 165°C (329°F)



# Caloritech™

## ENGINEERED ELECTRIC HEAT

### CCRI TRITON™ WASHDOWN UNIT HEATER

#### Features:

- NEMA 4X corrosion-resistant washdown heater, suitable for non-hazardous locations and applications using water pressure of less than 70 psi
- Available in a range of wattages, from 3 to 39 kW
- UL listed for Coast Guard and marine applications
- EAC marked



### GE REGULAR-DUTY FORCED AIR UNIT HEATER

#### Features:

- Designed for use in regular-duty industrial and commercial space heating applications
- Models range from 2 to 40 kW output
- Available in a range of voltages from 208 to 600 V
- CSA C/US certified
- CE marked for global markets
- EAC marked



### GX HEAVY DUTY FORCED AIR UNIT HEATERS

#### Features:

- Specifically engineered for heavy-duty use in industrial environments
- Available in 15–50 kW units (optional 10 kW unit); 40 and 50 kW units incorporate split loads (50%) for remotely controlled energy management systems
- CSA C/US certified
- CE marked for global markets
- EAC marked



### IMMERSION HEATERS

#### Features:

- Immersion heaters are mainly used for process heating in both hazardous and non-hazardous areas such as in tanks, pressure vessels, and pipe assemblies
- Process fluids include water, heavy and light hydrocarbons, acids, polymers, salts and gases
- Available in 500 W–2.5 MW depending on the element length and voltages from 110 V to 690 V
- High quality replacements for the most commonly used heater types
- CSA C/US certified
- CE/ATEX & IECEX marked
- EAC marked

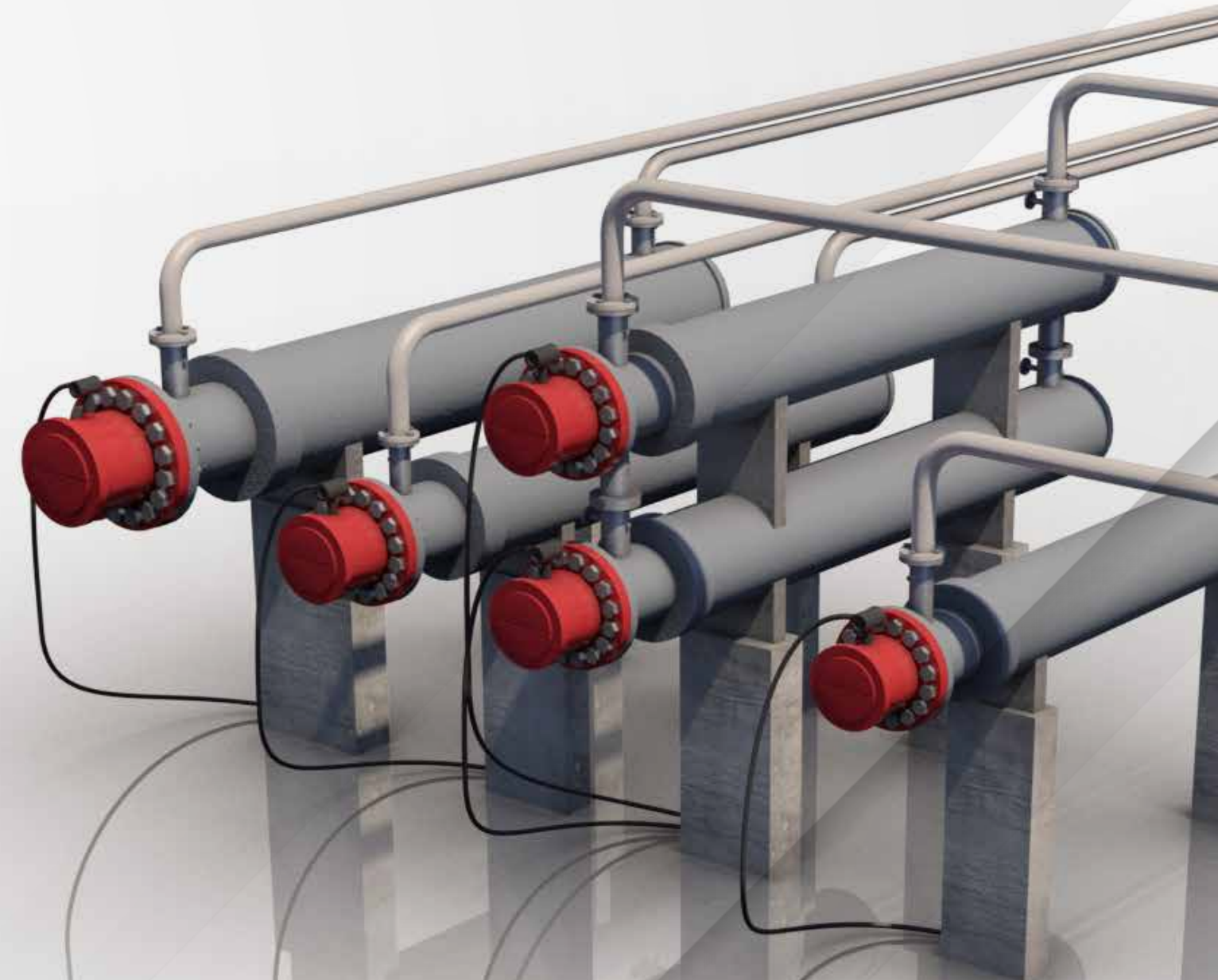

# Caloritech™

## ENGINEERED ELECTRIC HEAT

### PGH PILOT GAS HEATER

**Features:**

- Designed to heat the pilot tube gas stream of an automatic pressure reducing valve
- Combines a high efficiency aluminum casting with a digital temperature controller to maintain the pilot tube gas stream temperature, regardless of the gas flow rate
- The precise temperature control of this heater prevents damage to valve seals caused by freezing

of entrained moisture, while maintaining a temperature low enough to prevent damage caused by overheating

- Temperature code: T4
- Available in 250–750 W and 120 V, 208 V, and 240 V
- CSA C/US certified to Class I, Divisions 1 & 2, Groups A, B, C & D; Class II, Divisions 1 & 2, Groups E, F & G; Class III, Divisions 1 & 2; Class I, Zones 1 & 2, Group IIA, IIB & IIC



### HEAT TRANSFER SKID

**Features:**

- Custom designed, skid mounted unit provides process heat utilizing electric heaters to heat water, glycol, oil or heat transfer mediums
- Custom designs can incorporate water or steam boilers, super heaters and filtration equipment
- Available in wattages up to 5000 kW and voltages from 110 to 690 V

- Carbon steel or custom alloy materials
- PLC or hard-wired controls
- Certified to CSA C/US, IECEx, and CE/ATEX
- EAC marked
- ASME Section VIII, Division 1 or Division 2



### INDIRECT CIRCULATION HEATER

**Features:**

- Used primary in indirect heating applications where the process fluid needs to be isolated from the heating source or media
- Based on a helicoidal coil immersed in an oil bath that is heated by an electric immersion heater

- Typical applications include high pressure gas (above 3000 psi) and applications with low gas flow rates
- Certified to CSA C/US, CE/ATEX, IECEx, and B31.3 (on coil)
- EAC marked
- CE marked



### ENGINEERED SYSTEMS

**Features:**

- Customized heating, filtration, and process solutions in a turnkey package
- Complete switch gear and control packages
- Design registration

- ASME Section VIII, Division 1 and 2
- Certified to CSA C/US, IECEx, and CE/ATEX
- EAC marked
- ASME rated interconnecting piping
- Available on-site start-up and commissioning assistance

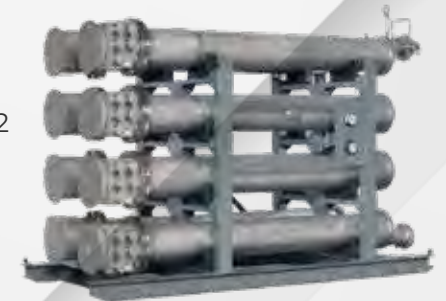

### CIRCULATION HEATERS

**Features:**

- For use in liquid and gas applications
- Available in horizontal or vertical orientations
- Available in vessel sizes up to 127 cm (50")
- Carbon steel or custom alloy materials

- Available in wattages up to 5000 kW and voltages from 110 to 690 V
- Certified to CSA C/US, IECEx, and CE/ATEX
- EAC marked for Eurasian markets
- ASME Section VIII, Division 1 or Division 2
- CE marked



### CONTROL PANELS

**Features:**

- Custom built to meet various environmental requirements, including dust, oil, and water, as well as corrosive or hazardous locations

- Certified to CSA C/US, UL, IECEx, and CE/ATEX
- EAC marked
- Designs suitable for Ordinary and Hazardous Locations Class I, Division 1, Groups C & D, Zone 1, flameproof & purged



# Caloritech™

## BOILERS

Caloritech™ by Thermon manufactures a wide variety of Boilers and Calorifiers including Circulation Heaters, Boiler Feed Pumps, Electric Steam Boilers, Hot Water Boilers and Condensate Receiver Package.



### HOT WATER BOILERS - TYPE VWB & HWB

- Ideally suited for process heating, comfort heating, commercial dishwashers, radiant floor heating and car wash.
- Safe, quiet and reliable source of hot water.
- Offered in 150 kW to 5000 kW with pressure ratings up to 2500 psig.
- CSA approved, and designed and built to the latest version of the ASME code.

### STEAM BOILERS - TYPE VSB & VWB

- Designed for dry cleaning applications, chemical distillation, autoclaves, heating jacketed vessels and more.
- Fully packaged systems for safe, versatile and easy to use heat sources for low or high pressure steam.
- Caloritech™ boilers have low water volumes for rapid response.
- Offered in 9 kW to 5000 kW with pressure ratings up to 2500 psig.
- CSA approved, and designed and built to the latest version of the ASME code.
- Space saving vertical vessels and top mounted vertically positioned flange heaters (VSB only) to minimize scaling, conserve floor space and simplify maintenance.
- Applications include chemical reactions and distillations, pipe tracing.
- Water heating, laundries, kitchen equipment and hospital equipment sterilization.



### PACKAGED CIRCULATION HEATERS - TYPE CWCB

- Designed for installation in circulating systems where space is limited.
- Standard configurations include commercial swimming pool heaters, side arm domestic water heaters, commercial dishwasher booster heaters or commercial hot water furnaces for comfort or process heating.
- Offered in 6 kW to 60 kW with pressure ratings up to 125 psig.
- Standard features include a galvanized shell, designed to the latest version of the ASME code, inlet, outlet, drain connections, heavy-duty copper sheathed flanged elements and a fully pre-wired control panel.



# Caloritech™

## BOILERS

### REPLACEMENT BOILER FLANGE HEATERS - TYPE CX

- Designed as replacement parts for boilers.
- Available in a range of sizes and styles to suit the requirements of different boiler units, including rectangular flanges, square flanges and round flanges.



### CALORIFIERS - TYPE HC & VC

- Type HCC & VCC (sprayed copper inner shell) is designed for high purity water.
- Type HCG & VCG (galvanized steel inner shell) is designed for hard water storage.
- Type HCF & VCF (uncoated steel shell) is designed for non-potable water heating.
- Type VCS (stainless steel shell)

#### Features:

- Available in a range of standard tank capacities and dimensions
- Tank weights range from 570 lbs (260 kg) to 3050 lbs (1380 kg)
- Standard features include a pressure relief valve, inlet water diffuser, temperature control thermostat, high limit thermostat, pressure gauge and 3" inspection opening; (optional manhole).



### BLOW OFF TANKS - TYPE BOT

- Designed to capture condensate from high pressure boiler discharges
- Available up to 125 gal. (565 L)
- Pressure gauge and drain valve are standard

### SOLENOID FEED MECHANISM - TYPE SF

- Designed to augment boiler operation in closed systems when condensate is to be returned to the boiler.



### BOILER FEED PUMP - TYPE BFP

- Designed to augment boiler operation if condensate is not required to be returned to the boiler and mains water pressure is not 10 psig or more above maximum boiler operating pressure.

### CONDENSATE RECEIVER PACKAGES - TYPE CRP

- For closed loop systems where condensate is to be returned to the boiler
- Available up to 86 gal. (390 L) for boilers up to 990kW
- Includes feed pump, make up water inlet with float control, sight glass, and shut off valve.



# 3L Filters™

## ENGINEERED FILTRATION SYSTEM

### GFS GAS FILTER SEPARATOR

**Features:**

- Removes moisture, liquid mists, aerosol, and contaminants from hydrocarbon gases using a three-stage design
- Horizontal or vertical configurations
- Designed to ASME Section VIII, Divisions 1 and 2 specifications
- Single, duplex or multiplex arrangement; skid package configuration with controls and heating equipment available
- -29°C/+66°C (-20°F/+150°F) standard design temperature



### FGCS FUEL GAS CONDITIONING SYSTEM

**Features:**

- Removes small amounts of moisture, liquid mist, and particulate contaminants from fuel gases
- Capabilities of gas preheating, superheating, pressure reduction, and gas metering
- Designed to deliver gas pressure, temperature, and degree of purity to meet custom specifications
- Approved for use in Class 1, Division 1, Group D hazardous locations



### L DEHYDRATOR

**Features:**

- Provides gross water removal from liquid hydrocarbon fuels such as aviation fuel, kerosene, gasoline, diesel and liquid propane to an efficiency of 99%
- Employs a variety of replaceable coalescent filter packs to trap particle contamination and coalesce water from fuel
- Designed to ASME Section VIII, Divisions 1 and 2 specifications
- 150 psig standard design pressure; custom design pressures
- -29°C/+66°C (-20°F/+150°F) standard design temperature



### FC SINGLE BAG FILTER HOUSING

**Features:**

- Provides effective, economical filtration of liquids
- Available in a wide range of materials and micron ratings to remove particulate matter down to 1 micron
- Designed to ASME Section VIII, Divisions 1 and 2 specifications
- Single, duplex, or multiplex arrangement
- 150 psig standard design pressure; custom design pressures
- -29°C/+66°C (-20°F/+150°F) standard design temperature



### BF MULTI-BAG FILTER HOUSING

**Features:**

- Provides economical bulk filtration for liquids
- Sized from 3 to 24 bags and accommodates replaceable filter bags to remove particulates down to 1 micron
- Designed to ASME Section VIII, Divisions 1 and 2 specifications
- Single, duplex or multiplex arrangement
- 150 psig standard design pressure; custom design pressures
- -29°C/+66°C (-20°F/+150°F) standard design temperature



### F & FD LUBE OIL, SEAL OIL & CONTROL OIL CARTRIDGE FILTER HOUSINGS

**Features:**

- Provides continuous particulate filtration for both critical and non-critical lube, seal and control oil applications
- Many standard F & FD systems conform to API 614 requirements for system components, including the filters and transfer valves, as well as the required controls and instrumentation
- Designed to ASME Section VIII, Divisions 1 and 2 specifications
- 150 psig @ 66°C (150°F) standard design pressure; custom design pressures
- -29°C/+93°C (-20°F/+200°F) standard design temperature; higher design temperatures available

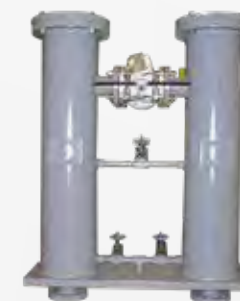

### F & FD LUBE OIL, SEAL OIL & CONTROL OIL CARTRIDGE FILTERS

**Features:**

- Aluminum cartridge hardware
- Standard cartridge lengths of 457 mm (18") and 914 mm (36")
- Quick access cartridge replacement
- Custom cartridge configurations, sizes and filter media available



### BSF FABRICATED BASKET STRAINERS

**Features:**

- Removes gross particles from a liquid stream
- Often used as a pre-filter placed before finishing filtration equipment
- Designed to ASME Section VIII, Division 1 and 2 specifications
- Single, duplex or multiplex arrangement
- 150 psig standard design pressure; custom design pressures
- -29°C/+93°C (-20°F/+200°F) standard design temperature



### FW GENERAL INDUSTRIAL CARTRIDGE FILTER HOUSING

**FEATURES:**

- Removes particulates from liquid streams, often as a pre-filter ahead of finer particle separation equipment
- Standard design is based upon a single or double open-ended cartridge, but can be adapted to many filter cartridge designs, configurations, and sizes
- 150 psig standard design pressure; custom design pressures
- -29°C/+66°C (-20°F/+150°F) standard design temperature; higher design temperatures available
- Designed to ASME Section VIII, Division 1 and 2 specifications

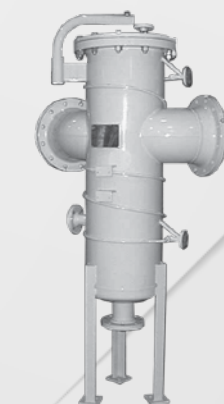

# 3L Filters™

## ENGINEERED FILTRATION SYSTEM

### SWC FULFLO® STRING WOUND FILTER CARTRIDGE

**Features:**

- Wide range of fibers and core materials
- Roving is wound onto a center core for strength
- Diagonal pattern of the media forms a tight, interlocking weave
- Nominal removal ratings from 1 µm to 100 µm are available
- FDA grade polypropylene (DOE only) certified to ANSI/NSF61 standard for contact with drinking water components



### PB FULFLO® PLEATED BAG SERIES

**Features:**

- Available in several polypropylene formats: Poly-Mate Plus, Poly-Mate, Claripor, and Glass-Mate media
- Designed to fit within existing bag filter vessels without any hardware
- changes and incorporates an easy-to-grasp integrated handle for quick removal
- Several media types are available for a wide variety of applications



### CS & BS CONE AND BASKET STRAINERS

**Features:**

- Protects fluid and gas handling equipment by removing debris during system start-up
- Available in stainless steel alloys or carbon steel; media available in a

- selection of four perforated styles and five mesh styles
- Custom builds available upon request



### FP FULFLO® FLO-PAC® FILTER CARTRIDGE

**Features:**

- The perfect choice for many industrial filtration requirements
- Contains premium grade, phenolic impregnated, cellulosic filter media
- Designed for critical filtration applications providing long service life, high flow rate, and low pressure drop

- Available in 0.5 µm, 1 µm, 5 µm, 10 µm, 20 µm, 30 µm, and 60 µm pore sizes (95% removal; β = 20)
- High strength spiral core withstands pressure surges to 100 psi
- Suitable for operating temperatures to 121°C (250°F)



### 336 FULFLO® 336 PLEATED CARTRIDGE

**Features:**

- Provides highly efficient removal of solid contaminants from a variety of applications
- Manufactured from premium grade phenolic impregnated cellulose and polypropylene blown media.
- Available in 3 µ, 10 µ, 12 µ, 22 µ, and 100 µ pore sizes. (99.98% removal; β = 5000)

- Retrofits housings that use 3" OD x 36" long SOE cartridges with a spring
- -29°C/+93°C (-20°F/+200°F) standard design temperature; higher design temperatures available



### 1401 FULFLO® 1401 PLEATED CARTRIDGE

**Features:**

- Designed to replace similar competitive cartridges in high pressure water injection & disposal, gas streams and fluid processing
- Available in cellulosic and polypropylene media

- Available in absolute ratings of 2.5, 6, 10, 12, 22, and 100 microns (99.98%, β = 5000)
- Retrofits into compatible housings that use 1401 style cartridges



### PRO FULFLO® PROBOND™ FILTER CARTRIDGE

**Features:**

- Features a unique, proprietary two-stage filtration design to maximize particle retention and service life in viscous fluid filtration applications
- Available in eight differentiated removal ratings of 2 µm, 5 µm,

- 10 µm, 25 µm, 50 µm, 75 µm, 125 µm and 150 µm pore sizes to meet a wide range of performance requirements
- Withstands pressure surges up to 150 psig across the cartridge (depending on fluid temperature)



# 3L Filters™

## ENGINEERED FILTRATION SYSTEM

### SSF STAINLESS STEEL CLEANABLE FILTER

**Features:**

- Provides effective filtration for gases and fluids in high temperature and flow rate applications
- Available in flat wrap or pleated format, and offer flexibility in particle removal ratings, size choices, and end cap configurations
- 20 standard particle removal ratings from 2 to 800 microns; various nominal particle size removal options



### FPE FULFLO® FLO-PAC® PLUS FILTER CARTRIDGE

**Features:**

- Manufactured with premium grade, phenolic impregnated cellulosic filter media for long service life, high flow rate, and low pressure drop
- Available in a variety of sizes and configurations to fit most industrial vessels
- Available in 0.5 µm, 1 µm, 5 µm, 10 µm, 20 µm, 30 µm, and 60 µm pore sizes (95% removal;  $\beta = 20$ )
- Suitable for operating temperatures to 121°C (250°F)



### MXG FULFLO® MAXGUARD™ FILTER CARTRIDGE

**Features:**

- Provides a cost effective alternative to bag media or standard 2½" cartridges for high flow applications
- Each MaxGuard™ cartridge has a 6" nominal outside diameter and can handle flows up to 90 gpm to significantly reduce the number of cartridges required for large flow applications
- Available in polypropylene, cellulose, and Nomex™ media



### MP ORIFICE (METERING) PLATE TOOL

**Features:**

- Used to alter the rate of fluid flow in a pipe
- Fluid flows through a pipe at a certain velocity and pressure, when the fluid reaches the orifice plate, it converges and is forced through the small hole of the plate, thereby altering the flow rate
- Custom builds, available upon request



### PS PLATE STRAINER TOOL

**Features:**

- Used to protect fluid and gas handling equipment by removing debris during start-up
- Easily installed or placed between large flange faces
- without modifying the surrounding pipe work
- Easily removed
- Custom builds, available upon request





# EnviroDyne™

## METHANE DESTRUCTION UNIT

### THERMON ENVIRODYNE METHANE DESTRUCTION UNIT

**Features:**

- The Thermon EnviroDyne™ MDU is a safe, highly efficient, and easy to install methane abatement solution for use in the reduction of fugitive gas emissions
- Targets the flameless conversion of methane to carbon dioxide and water vapor
- Designed for continuous use and only requires temporary electric power (often via a battery) for initial start-up
- The unit is designed to operate indefinitely once started and contains no moving parts



# Norseman™

## ELECTRIC EXPLOSION-PROOF HEATERS

### XB EXPLOSION-PROOF NATURAL CONVECTION HEATER

**Features:**

- Designed for heating applications where explosive substances may be present, such as control cabinets and small enclosures
- Safe and reliable heater offers state-of-the-art design, featuring Thermon Heating Systems' unique copper-free aluminum extruded converter and patented x-Max® terminal housing
- A range of voltages available, from 120 to 600 V, depending on heater configuration
- A range of wattages available, from 475 to 5000 W, depending on heater configuration
- Temperature codes: T2D, T3B, T4A or T6
- CSA C/US certified
- CE/ATEX
- EAC marked

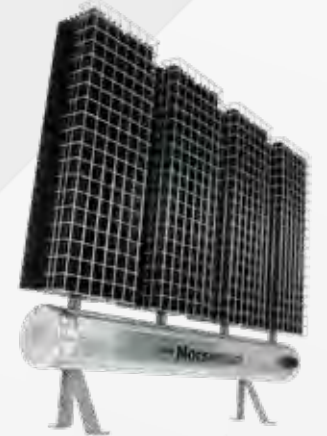

### XGB EXPLOSION-PROOF FORCED AIR UNIT HEATER

**Features:**

- Designed for heating industrial spaces where explosive atmospheres may exist
- Two sizes available; small cabinet units rated up to 10 kW and large cabinet units rated up to 35 kW
- CSA certified for Class I, Division 1 & 2, Groups C & D and Class II, Division 1 & 2, Groups E, F & G hazardous locations
- Temperature codes: T2C, T2D, T3A or T3B
- EAC marked



### XPA EXPLOSION-PROOF PANEL HEATER

**Features:**

- Designed specifically for freeze protection of control enclosures in locations where explosive atmospheres may exist
- Available in 50–700 W and 120 V, 208 V and 277 V configurations
- Suitable for both 50 Hz and 60 Hz
- CSA C/US certified for Class I, Division 1 & 2, Groups A, B, C & D hazardous locations
- Temperature codes: T2 (215°C), T3 or T4
- EAC marked
- CE/ATEX
- IECEx



XPAS Panel Heater Mounted In a Control Panel



# Fastrax™

## TRANSPORTATION HEATERS

### HELLFIRE GAS FIRED FORCED AIR SWITCH HEATER

Hellfire 400 and Hellfire 900 series gas fired forced air heaters melt and evaporate ice and snow from point to heel of railway switches.

Each system consists of a blower, combustion chamber, and ducting to distribute heated air over the entire switch via point nozzles and track duct.

#### Ratings/Features:

- The air temperature is thermostatically regulated for safe operation and maximum snow clearing performance.
- Heat output ranges 200,000 to 400,000, and 300,000 to 900,000 BTU/hr.
- Factory set to operate on propane, simple regulator adjustment for natural gas.
- Multiple standard duct system configurations. Custom duct systems available.
- Electrically isolated duct work meets AREMA dielectric strength standard 3000-volts AC RMS
- Intermittent or Continuous Fan operating modes
- Voltages range from 208 to 575.
- 14-gauge galvanized steel blower, intake, and duct work. Ducts in contact with ballast are 11-gauge Hot Dipped Galvanized. Track ducts are 18-gauge electroplated zinc steel.
- Stainless steel burner and combustion chamber transition duct.
- Remote dispatch operation and indication, relay based.
- Optional low or high profile air intakes.
- ArcticSense option allows automatic operation, optimizing energy efficiency without compromising performance.
- Remote control and monitoring possible via RS-485 port communications.



### SWITCHBLADE® ELECTRIC ELEMENT RAIL HEATERS

Switchblade electric element heaters clear ice and snow from point to heel of railway switches.

Elements fasten to and directly heat the rail by conduction. The heated rails heat the tie plates and melt snow and ice allowing the points to move freely.

#### Ratings/Features:

- Patented SwitchBlade® heaters design
- Flat profile design maximizes heat transfer and increases energy efficiency.
- Stainless-steel heavy-duty construction resists corrosion and offers protection and durability in rugged railroad environments.
- Available in any length up to 26 feet.
- Available in AC or DC voltages.
- Watt densities of 100 to 500 W/ft.
- Utilizes Fastrax® patented spring clamp technology allowing for expansion and contraction of the heater without binding or losing contact with the rail. No drilling required.



### CRIB HEATERS

Crib heaters eliminate ice and snow in the crib area at the critical switch point allowing for easy maintenance of switch rods and smoother switch operation. Exclusive jack bolt technology ensures secure fit, eliminating movement and potential switch fouling.

#### Ratings/Features:

- Heavy gauge aluminum construction resists corrosion and offers protection and durability in rugged railroad environments
- 26 ft premium grade marine power cable lead is resistant to chemicals and severe weather
- Model lengths range from 4' to 8'8"
- Standard wattages range from 600 W to 2700 W
- Available in AC or DC voltages, from 120 V to 750 V

### CONTROL PANELS – ELECTRIC ELEMENT

The control panel forms an integral part of a railway switch heating system that safely controls the heating of multiple switches and provides automatic operation based on ArcticSense snow detection.

#### Ratings/Features:

- Ground fault protection
- Individual heater circuit breaker protection
- Local controls and annunciation lights
- Adjustable or indefinite run time
- UL and ULC approved electrical components
- Mounted safety/service disconnect
- Terminal connections for field wiring
- Internal panel heater
- Tamper proof, safe “dead-front” design
- NEMA 4X stainless steel enclosure for AC
- Available from 120 V to 600 Vac, or up to 750 VDC
- Custom designs and layouts available.
- Each panel provides dispatch control and indication.

#### DC Specific Ratings/Features:

- NEMA 4 Fiberglass enclosure
- Hermetically sealed contactors
- 1000 V DC rated components
- Load breaking disconnect switch
- Isolated high voltage section
- GPO-3 nonconductive back pan



# Fastrax™

## TRANSPORTATION HEATERS

### FEB ELECTRIC HOT AIR SWITCH HEATER

The FEB series Electric Hot Air Blower switch heater prevents or removes ice and snow build up in the switch point area by delivering high velocity heated air distributed via point nozzles and track duct system over the entire switch.

#### Ratings/Features:

- The air temperature is thermostatically regulated for safe operation and maximum snow clearing performance.
- Standard 20 kW, 40 kW and 60 kW units
- Custom configurations and wattages to suit any track heating application
- Fully enclosed all aluminum construction
- Electrically isolated duct work meets AREMA dielectric strength standard 3000-volts AC RMS
- Ground and aerial snow sensors for automatic operation
- Rugged industrial modular electric heater design
- Automated fan shutdown delay for overheat protection
- Multi-stage energy saving operation (independent hot/cold operation)
- NEMA 4 electric enclosure for moisture protection in outdoor applications
- Low- or high-profile air intakes

### HAC – HIGH VELOCITY AMBIENT AIR BLOWER

Fastrax™ HAC Horizontal Air Curtain Series produce a high velocity curtain of ambient air to prevent the accumulation of ice and snow in railway switches. The HAC consist of a compact blower unit and ducting system that delivers airflow to the switch mechanism.

The blower unit is an electrically powered centrifugal fan equipped with a low velocity air intake. The blower output is ducted below the rails to nozzles mounted within the railway switch. From the two point nozzles, 120 - 140 mph high velocity air streams are directed towards the point of the switch.

Fastrax™ QHAC Series Quiet Horizontal Air Curtains are designed for use in residential areas, with reduced sound pressure levels below 60 dbA at 50 feet.

#### Ratings/Features:

- Rotating nozzles and adjustable vane to direct air where needed
- Air volume output, 5 HP 2500 cfm, 7.5 HP 3000 cfm.
- Motor starting contactor with overload protection
- Electrically isolated duct work meets AREMA dielectric strength standard 3000-volts AC RMS
- Standard HAC series - 65 dbA at 50 feet
- Quiet (low noise) QHAC series - 60 dbA at 50 feet
- Remote dispatch operation and indication, relay based.
- Optional low or high profile air intakes.
- ArcticSense option allows automatic operation, optimizing energy efficiency without compromising performance.
- Remote control and monitoring possible via RS-485 port communications.



# Velocity™

## TRANSPORTATION HEATERS



## FORCED AIR HEATERS

### Ratings/Features:

- Fully customized to suit customer specifications
- Lab certified qualification tested to ensure reliable performance and safe operation
- Elements: Open coil, tubular, strip heater, Calvane™
- Fans: Axial, centrifugal, radial
- Controls: Digital controller, thermostats, fan speed control, remote indicators
- Rugged/robust design
- High resistance to shock and vibration
- Fast heat up and cool down response times
- Light weight
- Low noise
- High quality components
- Long lifespan

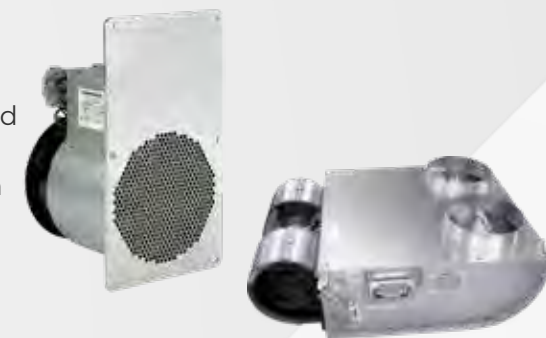

## FLOOR HEATERS

### Calvane Heater Assemblies

- Standard Calvane™ and louvered Calvane™
- Length Range: 10" to 83"
- Width: 2¼" or 3¼"
- Fast start-up and cool down periods
- No magnetic noise
- Low pressure drop
- Resistance to damage from shock and vibration
- Easily isolated for high voltage applications
- Uniform heat distribution
- Low watt density for long life performance

### Strip Heaters

- Standard, finned or sealed
- Length Range: 5.5 ½" to 42 ¼"
- Element Material: Aluminized steel, or stainless steel

### Radiant In-Floor Heaters

- Semi-permanent adhesive for ease of maintenance
- Even heat distribution,
- Durable construction



## DUCT HEATERS

### Ratings/Features:

- Elements: Open coil, tubular, finned tubular
- Element Configuration: Straight, Hairpin, W-shape, Helical
- Fully protected against mechanical shock, vibration or breakage.
- Low element mass yields relatively small amounts of residual heat on fan shut down, reducing heat effect on surrounding material.
- Static pressure drop through open coil is very low, reducing fan horsepower requirements



## THRESHOLD & DOOR POCKET HEATERS

### Door Pocket

These heaters are engineered to eliminate frost and snow from interfering with door operation. We offer a variety of designs incorporating strip heaters, tubular elements or silicon pad heaters.

### Threshold

Threshold heaters eliminate frost and snow build up on door threshold areas to help passengers safely enter and exit the train. Only Thermon Heating Systems offers the robust Calbar™ element for threshold heating applications. Tubular style heating elements and silicone pads are also available.

### Ratings/Features:

- Watertight design
- Durable construction
- Resistance to shock, vibration and friction
- Compact size
- Corrosion resistant



# POWER SOLUTIONS

**Thermon Power Solutions (TPS)** is the electrical manufacturing/fabrication division of Thermon, the leading provider of portable power distribution and lighting equipment for industrial applications.

Our product portfolio is available for sale and rent and is categorized into three types:

**General Purpose (GP)** – Greenfield construction projects, brownfield projects, as well as shutdown/turnarounds where the entire area has been declassified.

**Hazardous Locations (HL)** – Class I, Division 2 – shutdowns/turnarounds and brownfield projects where explosive gases/dusts may be present. Class 1, Division 1 lighting available for vessel work

**Custom Projects** – Custom designed and engineered equipment to meet your unique project needs.

TPS is your permanent solution for temporary power!



## TEMPORARY POWER SOLUTIONS DISTRIBUTION CENTERS - GENERAL PURPOSE

### MAIN DISTRIBUTION CENTER (MDC-GP) – TYPE 1

#### Applications:

- Distributing 480 or 600 V power throughout General Purpose Areas
- Early energization of high mast lighting on construction sites
- Welding machines
- Ratings/Features:
- 3 PH, 600 V splitter with ratings up to 2000 amp
- Optional fused disconnect, c/w fast acting fuses
- Optional 1200 amp main breaker with adjustable trip.
- Optional plug & play connections up to 200 amp available to feed downstream equipment.
- Engineered steel stand with lifting lugs and forklift pockets
- NRTL certified for general purpose locations. Rated for NEMA 3R environments.

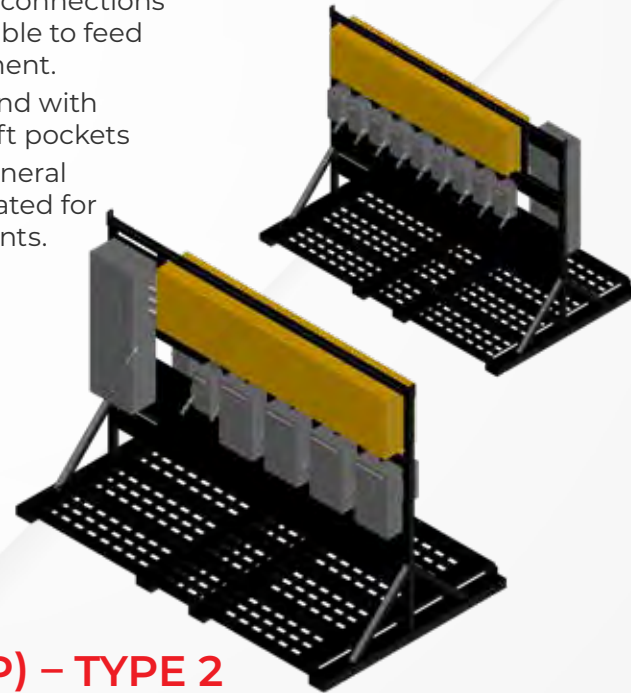

### MAIN DISTRIBUTION CENTER (MDC-GP) – TYPE 2

#### Applications:

- Connecting to site distribution up to 25 kV
- Distributing 480 or 600 V power throughout General Purpose Areas
- Early energization of high mast lighting on construction sites
- Welding machines
- Optional fused disconnect, c/w fast acting fuses.
- Optional 1200 amp main breaker with adjustable trip.
- Optional plug & play connections up to 200 amp available to feed downstream equipment.
- Engineered steel skid with lifting lugs
- NRTL certified for general purpose locations. Rated for NEMA 3R environments.

#### Ratings/Features:

- Up to 1.5 MVA, 25 kV to 600/347 V, oil filled or dry type, NEMA 3R transformer
- 3 PH, 600 V splitter with ratings up to 2000 amp

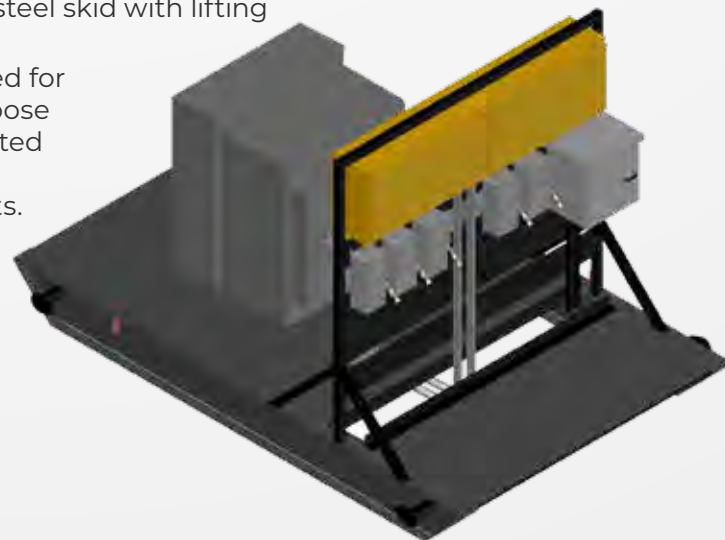

### MAIN DISTRIBUTION CENTER (MDC-GP) – TYPE 3

#### Applications:

- Connecting to site distribution up to 25 kV using a ring bus distribution design for increased reliability
- Distributing power throughout General Purpose Areas
- Early energization of high mast lighting on construction sites
- Welding machines
- Optional fused disconnect, c/w fast acting fuses.
- Optional 1200 amp main breaker with adjustable trip.
- Optional plug & play connections up to 200 amp available to feed downstream equipment.
- Engineered steel skid with lifting lugs
- NRTL certified for general purpose locations. Rated for NEMA 3R environments.

#### Ratings/Features:

- Up to 1.5 MVA, 25 kV to 600/347 V, oil filled or dry type, transformer
- 3 PH, 600 V splitter with ratings up to 2000 amp



### REMOTE DISTRIBUTION CENTER (RDC-GP) – TYPE 1

#### Applications:

- Providing power to 480/600 V loads and 120/208 V loads in General Purpose Areas

#### Ratings/Features:

- Dual voltage panel consists of back side equipped with 600 V breakers and Meltric Plug & Play connectors for 480 or 600 V loads such as welding machines
- Front side of dual voltage panel comes standard with 12 x duplex receptacles fed from GFCI breakers, and 3 x 120/240 V, 20 amp twistlock receptacles.
- Additional breakers can be added as required
- Plug and Play connections used for Main and Sub Panels in adjacent work areas can be

energized or deenergized under load i.e. “make” or “break” (no need for time consuming isolation practices)

- Standard 45 kVA dry type transformer, custom options available
- Aluminum enclosure with pad lockable doors, powder coated finish and stainless steel hardware
- Engineered steel skid with lifting lugs and forklift pockets
- Optional protective roof and convenience lights available
- Cart style available with heavy duty rolling casters
- NRTL certified for general purpose locations. Rated for NEMA 3R environments.



### REMOTE TRAILER DISTRIBUTION CENTER (RTDC-GP)

#### Applications:

- Ideal for supplying power to project site infrastructure i.e. lunch trailers, wash cars, office trailers and office complexes, warehouse buildings, fabrication tents etc. in General Purpose Areas

#### Ratings/Features:

- Up to 300 kVA transformer options
- Distribution panel may be equipped with main breaker if required, comes with breaker as required for trailers etc.

- Optional fused disconnect available on primary side of transformer
- Optional protective roof and convenience lights available
- Optional terminal box assembly for connection to field cables such that terminals are pre-wired to breakers.
- Optional data panel available for site data cables, fiber etc.
- Engineered steel stand with lifting lugs and forklift pockets
- NRTL certified for general purpose locations. Rated for NEMA 3R environments.



## TEMPORARY POWER SOLUTIONS PANELS - GENERAL PURPOSE

### MAIN PANEL – GENERAL PURPOSE

#### Applications:

- Providing power to Sub Panels and 120 V loads
- Ground faults can be reset locally on working platform

#### Ratings/Features:

- 1 x 120/240 V, 60 amp incoming Plug & Play connector
- 2 x 1 PH, 120/240 V, 30 amp feeder/outgoing Plug & Play connector to provide power to Sub Panels
- 3 x 20 amp, weatherproof duplex receptacles fed from GFCI breakers
- Scaffold/handrail clamping devices c/w safety lanyard
- Lightweight aluminum enclosure with pad lockable doors, powder coated finish and stainless steel hardware
- NRTL certified for general purpose locations. Rated for NEMA 3R environments.



### STAGHORN PANEL – GENERAL PURPOSE

#### Applications:

- Providing power to 120 V loads
- Ideal for work on elevated platforms
- Ground faults can be reset locally on working platform

#### Ratings/Features:

- 120/240 V, 20 amp incoming twist-lock plug
- 4 x 20 amp weatherproof GFCI protected duplex receptacles fed from 2 x 20 amp breakers
- Optional scaffold/handrail clamp c/w safety lanyard
- NRTL certified for general purpose locations. Rated for NEMA 3R environments.



### SUB PANEL – GENERAL PURPOSE

#### Applications:

- Providing power to 120 V loads
- Ideal for work on elevated platforms

#### Ratings/features:

- 1 x 120/240 V, 30 amp incoming Plug & Play connector
- 5 x 20 amp, weatherproof duplex receptacles fed from GFCI breakers
- Ground faults can be reset locally on working platform
- Scaffold/handrail clamping devices c/w safety lanyard
- Lightweight aluminum enclosure with pad lockable doors, powder coated finish and stainless steel hardware
- NRTL certified for general purpose locations. Rated for NEMA 3R environments.

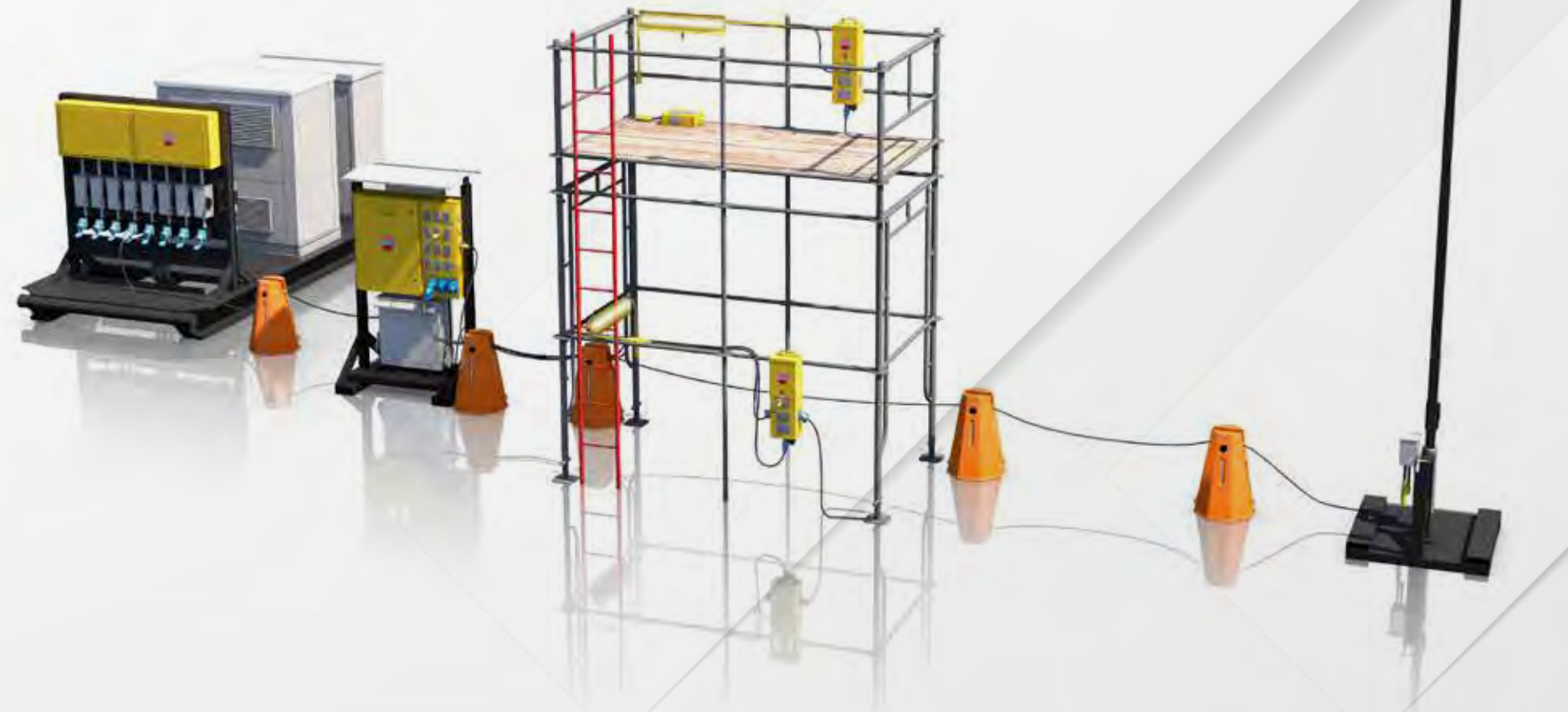



## TEMPORARY POWER SOLUTIONS ACCESSORIES - GENERAL PURPOSE

### THERMON TASK LIGHT – GENERAL PURPOSE

#### Applications:

- Ideal for detailed work such as welding, cleaning, cutting etc. in General Purpose Areas.
- Providing task and walkway lighting

#### Ratings/Features:

- Approximately 3800 Lumen output
- Standard operating voltage, 120 V. Optional input voltages available.
- Durable polycarbonate lens
- NEMA 4X enclosure, IP 66
- Scaffold/handrail clamping devices c/w safety lanyard
- NRTL certified for general purpose locations. Rated for NEMA 3R environments.



### LED AREA LIGHT TOWER

#### Applications:

- Provide general area lighting for parking lots, walkways, laydown areas and open work areas in General Purpose Areas

#### Ratings/Features:

- 3 x 19,000 lumen (approx.) LED's
- Robust engineered steel base rated for wind loads when pole is in the fully extended position, c/w forklift pockets for easy site movement
- Extends up to 9 m (29')
- Standard operating voltage, 120 V. Optional input voltages available.
- Plug & Play quick connect at the bottom of the pole for quick connection to incoming power, photocell controlled
- Connectors at the bottom of the pole for quick connection to incoming/outgoing power
- NRTL certified for general purpose locations. Rated for NEMA 3R environments.



### GENERAL PURPOSE CORDS

#### Applications:

- Ideal for small tool power and lighting located in a work area (i.e. drills, grinders, rod ovens, cutters, heaters etc.) in General Purpose Areas

#### Ratings/Features:

- Various options available in SOOW cable including Super Vutron
- Flexible power cable available in the following lengths; 8 m (25'), 15 m (50'), 30 m (100'), to be specified in part number when ordering
- Watertight plugs and connector (various options available)
- NRTL certified for general purpose locations. Rated for NEMA 3R environments.

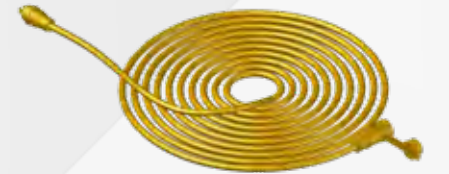

### GENERAL PURPOSE Y CORDS

#### Applications:

- Ideal for work involving multiple power tools (i.e. grinders and buffers) in General Purpose Areas

#### Ratings/Features:

- Watertight plug and connector (various options available)
- NRTL certified for general purpose locations. Rated for NEMA 3R environments.

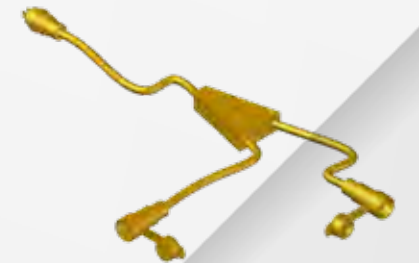

### PLUG & PLAY CORD SETS – GENERAL PURPOSE

#### Applications:

- Plug & Play cord sets to feed all downstream panels and/or additional loads

#### Ratings/Features:

- Available in the following lengths: 8 m (25'), 15 m (50'), 30 m (100')
- Plug & Play connectors, switch rated and breakable under load providing full Arc Flash protection for workers
- NRTL certified for general purpose locations. Rated for NEMA 3R environments.



## TEMPORARY POWER SOLUTIONS DISTRIBUTION CENTERS - HAZARDOUS LOCATIONS

### TEMPORARY POWER WELDING DISTRIBUTION (TPWD-HL) – HAZARDOUS LOCATIONS

#### Applications:

- 600 V power distribution for hazardous location areas through a factory sealed, fully wired system.
- Ideal for, but not limited too, powering multiple welders, heat treaters, and RDC-HL's.

#### Ratings/Features:

- Incoming JB c/w power distributions blocks for site connection.
- 3 PH, 600 V, 225 amp, 18 cct panel, c/w 6 x 60 amp, 3 PH factory sealed breakers wired to JB's on the backside.
- JB's c/w power distribution blocks for load termination with no need for panel access.
- Engineered steel skid with forklift pockets, steel grating, rain hood, and lifting lugs.
- NRTL certified for hazardous locations, Class I Division 2, Groups B, C & D. Rated for NEMA 3R environments.



## REMOTE DISTRIBUTION CENTER (RDC-HL) – HAZARDOUS LOCATIONS – TYPE 1

#### Applications:

- Providing power to 120 V loads in hazardous areas (Class I, Zone II) with ground fault protection
- Ideal for in plant maintenance work, major shutdowns and turnarounds

#### Ratings/Features:

- Various options available for a fused disconnect on the primary side of the 480 or 600 V transformer or additional 600 V loads
- Design based on Appleton's PowerPlex labyrinth flameproof technology where standard industrial style breakers are secured inside individual housings
- 12 x 20 amp panel mount receptacles all powered through the GFCI breakers
- 1 x 60 amp Plug & Play connector used to power Main Panel

- 2 x 20 amp Meltric Plug & Play connector used for Sub Panel powered through the breaker
- Plug & Play connections suitable for current interruption
- Up to 45 kVA transformer, optional voltages available
- Engineered steel stand with lifting lugs and forklift pockets
- Cart style available with heavy duty rolling casters
- Extra 600 V distribution available upon request
- NRTL certified for hazardous locations, Class I Division 2, Groups B, C & D. Rated for NEMA 3R environments.



## REMOTE DISTRIBUTION CENTER (RDC-HL) – HAZARDOUS LOCATIONS – TYPE 2

#### Applications:

- Ideal for in plant maintenance work, major shutdowns and turnarounds
- Plug & Play connections for up to 8 Sub Panels for congested work areas, multiple platforms etc.

#### Ratings/Features:

- 60 amp, 600 V fused disconnect on primary side of transformer
- Design based on Appleton's PowerPlex labyrinth flameproof technology where standard industrial style breakers are secured inside individual housings
- 1 x 40 amp Meltric Plug & Play connector used for Main panel powered through the protection breaker in the adjacent panel.
- 8 x 20 amp Meltric Plug & Play connector used for Sub Panel powered through the protection breaker in the adjacent panel
- Meltric Plug & Play connections available for Main and Sub Panels all powered through the protection breaker in the adjacent panel.

- Plug & Play connectors that can be energized or deenergized under load ("make" or "break") in hazardous areas (no need for time consuming isolation practices)
- Standard 45 kVA dry type transformer, custom options available
- Gasketed aluminum enclosure with pad lockable doors, powder coated finish and stainless steel hardware
- Engineered steel stand with lifting lugs and forklift pockets
- Cart style available with heavy duty rolling casters
- Optional protective roof and convenience lights available
- Extra 600 V distribution available upon request
- NRTL certified for hazardous locations, Class I Division 2, Groups B, C & D. Rated for NEMA 3R environments.



## TEMPORARY POWER SOLUTIONS DISTRIBUTION CENTERS - HAZARDOUS LOCATIONS

### MAIN PANEL – HAZARDOUS LOCATION

#### Applications:

- Providing power to Sub Panels in hazardous areas
- Ideal for in plant maintenance work, major shutdowns and turnarounds
- Ideal for work on elevated platforms where additional Sub Panels are required

#### Ratings/features:

- 1 x 3 PH, 120/208 V, 40 amp breaker feeding incoming Plug & Play connector
- 3 x 3 PH, 120/208 V, 20 amp feeder/outgoing Plug & Play connector for Sub Panels
- Scaffold/handrail clamping devices c/w safety lanyard
- Gasketed lightweight aluminum enclosure with pad lockable doors, powder coated finish and stainless steel hardware
- NRTL certified for hazardous locations, Class I Division 2, Groups B, C & D. Rated for NEMA 3R environments.



### SUB PANEL – HAZARDOUS LOCATION

#### Applications:

- Providing power to 120 V loads in hazardous areas with ground fault protection
- Ideal for in plant maintenance work, major shutdowns and turnarounds
- Ideal for work on elevated platforms

#### Ratings/features:

- 1 x 3 PH, 120/208 V, 20 amp incoming Plug & Play connector
- 4 x 20 amp, 120 V panel mount receptacles fed from GFCI breakers
- Ground faults can be reset locally on working platform
- Scaffold/handrail clamping devices c/w safety lanyard
- Gasketed lightweight aluminum enclosure with pad lockable doors, powder coated finish and stainless steel hardware
- NRTL certified for hazardous locations, Class I Division 2, Groups B, C & D. Rated for NEMA 3R environments.



### THERMON TASK LIGHT – HAZARDOUS LOCATION

#### Applications:

- Ideal for detailed work such as welding, cleaning, cutting etc. in hazardous areas
- Providing task lighting on work platforms

#### Ratings/Features:

- Approximately 3800 Lumen output
- Standard operating voltage, 120 V. Optional input voltages available.
- Durable polycarbonate lens
- NEMA 4X enclosure, IP 66
- Patent protected scaffold/handrail clamping devices c/w safety lanyard
- NRTL certified for hazardous locations, Class I Division 2, Groups B, C & D. Rated for NEMA 3R environments.



### LED AREA LIGHT TOWER – HAZARDOUS LOCATION

#### Applications:

- Provides general area lighting in hazardous locations
- Helps reduce the need for hot work permits and gas monitoring in operating facilities
- Ideal for operating facilities, maintenance projects and/or turnarounds where 24/7 lighting is required

#### Ratings/Features:

- 3 x 19,500 lumen (approx.) LED's
- Robust engineered steel base rated for wind loads when the pole is in the fully extended position, c/w forklift pockets for easy site movement
- Extends up to 9 m (29')
- Standard operating voltage, 120V. Optional input voltages available.
- Connectors at the bottom of the pole for quick connection to incoming/outgoing power
- NRTL certified for hazardous locations, Class I Division 2, Groups B, C & D. Rated for NEMA 3R environments.



### HAZARDOUS RATED EXTENSION CORDS

#### Applications:

- Ideal for small tool power and lighting located in a work area (i.e. drills, grinders, rod ovens, cutters, heaters etc.) in hazardous areas

#### Ratings/Features:

- Various options available in SOOW cable including Super Vutron
- Flexible power cable available in the following lengths: 8 m (25'), 15 m (50'), 30 m (100')
- NRTL certified for hazardous locations, Class I Division 2, Groups B, C & D. Rated for NEMA 3R environments.



### HAZARDOUS RATED Y CORDS

#### Applications:

- Ideal for work involving multiple power tools (i.e. grinders and buffers) in hazardous areas

#### Ratings/Features:

- Hazardous rated plug and two connectors
- NRTL certified for hazardous locations, Class I Division 2, Groups B, C & D. Rated for NEMA 3R environments.



### HAZARDOUS RATED CORD SETS

#### Applications:

- Plug & Play cord sets to feed all downstream panels and/or additional loads

#### Ratings/Features:

- Flexible power cable available in the following lengths: 8 m (25'), 15 m (50'), 30 m (100')
- Plug & Play connections suitable for current interruption
- NRTL certified for hazardous locations, Class I Division 2, Groups B, C & D. Rated for NEMA 3R environments.



# POWERBLANKET SOLUTIONS

## POWERBLANKET PRODUCTS COMPLETE THERMAL SOLUTIONS



### POWERBLANKET PRODUCTS

#### Features:

- The Powerblanket product line provides portable and easy-to-use freeze protection, insulation and heating.
- Built with a rugged vinyl shell that is safe to use in temperatures as low as -20°F (-29°C)
- Powerblanket Lite products are built for smaller scale heating jobs with a lower density but offer the same safety and energy efficiency as our other Powerblanket products

### DRUM AND BUCKET HEATERS

#### Features:

- Safety protect equipment and critical materials to improve viscosity and flow to temperature-sensitive materials with an insulated, full wrap design that prevents hot and cold spots and ensures safe, distributed heat throughout the container. Works on steel and poly drums.
- Powerblanket products offer three thermostatic control options: Powerblanket Pro with adjustments from ambient up to 145°F/63°C (+ 5°F/3°C)\*
- Powerblanket RR Series utilized Rapid Ramp technology to quickly heat materials to a pre-set safe 100°F/38°C (+ 10°F/6°C), or 80 or 120°F\*
- Powerblanket Hazardous Location Series features CID2 Hazardous area product options
- Available in sizes for 50, 30 and 15-gallon drums and a 5-gallon bucket size. Ask about custom-sized Powerblanket to fit specific insulated heating needs.

\*Product temperatures may vary depending on boundary conditions



### TOTE HEATERS AND DEF STORAGE HEATERS

#### Features:

- Designed to safely distribute heat evenly around the tote to maintain optimal heating conditions for temperature sensitive materials and solve viscosity issues. Built to be durable and weather resistant
- Adjustable thermostatic controller and internal thermostats
- Fully enclose, heat and protect the tote and pump housing unit
- Hazardous Area CID2 Products
- Powerblanket DEF Tote Heaters are temperature specific to protect Diesel Exhaust Fluid from freezing. Customized DEF bulk storage tanks also available upon request



## POWERBLANKET PRODUCTS BULK MATERIAL WARMERS



### POWERBLANKET HOT BOXES

#### Features:

- Hot boxes are constructed with a durable vinyl shell and are ideal for cold weather storage, freeze protection, transporting, job site heating, remote location use and winter roofing
- Efficiently heat temperature sensitive materials such as paints, roofing materials, chemicals, epoxies, resins, equipment, and pallets of any material
- Preserves temperature sensitive material
- Quick and easy assembly for portability and storage
- Certified to UL/CSA standards

#### Powerblanket's Hotbox is available in three options:

**Powerblanket Lite Hotbox (800 Watts) is available in two sizes available, 40"x48" or 36"x48" pallets**

**Powerblanket Hotbox Higher wattage (1200 Watts) for faster heating times & more extreme conditions**

#### Powerblanket Premium Hotbox

- A larger footprint (Fits 48" x 48" pallet)
- An internal steel frame
- The highest wattage (1440 Watts)
- A controller for precise temperature regulation

### GAS CYLINDER WARMERS

#### Features:

- Powerblanket's top quality gas cylinder heaters can help overcome the effects of cold weather
- Maintain pressure and efficiency on gas cylinders
- Increase performance and efficiency of gas cylinders
- Optimize gas and material usage to get the most out of every tank.



## POWERBLANKET PRODUCTS FLAT HEATED BLANKETS



### CONCRETE CURING BLANKETS

#### Features:

- The advanced technology used in Powerblanket heated Concrete Curing Blankets offer a manageable solution for curing concrete in cold and adverse weather conditions
- Cures concrete 2.8 times faster than conventional insulated blankets
- It spreads heat so evenly that the corners and edges of the concrete receive protection
- Produces cold weather concreting strength of up to 3,925 psi in 72 hours
- Maintains moisture throughout hydrating process
- Year-round applications include precast, concrete counter tops and decorative concrete

### GROUND THAWING HEATED BLANKETS

#### Features:

- Powerblanket Ground Thawing Blankets help tackle the difficulty of thawing ground in harsh climates
- High watt density thaws frozen ground surface, up to 12-18 inches per day
- Quickly remove frost prior to concrete pour
- Melt snow and ice from roofs, walkways, and construction areas.



## POWERBLANKET PRODUCTS COMPLETE THERMAL SOLUTIONS

### CUSTOM PIPE HEATERS

#### Features:

- Powerblanket advanced pipe heaters offer freeze protection with simple design that works with valve, manifold and instrumentation heaters.
- Pipe heating provides a product for that important element in between
- Keep the fluids flowing all year long through temperature-controlled pipe heating solution.



### VALVE HEATERS

#### Features:

- Powerblanket valve heaters offer freeze protection without inrush current issues
- For valves, such as gate valves and ball valves, and for critical parts of pipe and manifold systems.



### CHEMICAL TANK HEATERS

#### Features:

- Chemical tank heaters are thermal wraps that provide consistent, even heat across the tank's surface. Storing chemicals safely will help protect employees and the environment
- Heating chemicals for use is just as essential: proper care during heating ensures chemicals won't burn, combust or cause damage to facilities (or worse, cause harm to workers).
- Temperature maintenance drastically affects the performance of certain chemicals. Allowing temperatures to drift from the optimum range negatively impacts process repeatability, reaction optimization, throughput, and quality, especially for large storage tanks.
- Even, consistent heat from Powerblanket chemical tank heaters ensure that chemicals are reliable and safe to use even in cold weather conditions.



# TRAINING AND SERVICES

## THERMON PRODUCT TRAINING AND SERVICES

Thermon offers multiple levels of competitively-priced training to all of our valued customers. Students get a combination of practical and hands-on training—from basic operations of the many different controllers to the final connections of communications and supervisory software.

This highly recommended training gives site staff and contractors the confidence and ability to operate heat tracing systems to their full ability, saving time and money and preventing unnecessary down time due to failed equipment.

### Construction and Commissioning Services

- Complete EHT System Installation (Heat Tracing, Tubing Bundles, Power/End Kits & JB's, RTDs, Controllers, Power Distribution, Insulation)
- QA/QC, Testing, Documentation & Support
- Comprehensive Controller, EHT, RTD and Communication Commissioning
- Baseline Testing & Design Confirmation
- Deficiency Management & Rectification
- Fielding Engineering and Design Support

### EHT Audits

- Visual inspection and walk down of each circuit to inspect thermal insulation.
- Visual inspection of the heating system components.
- Inspection of controller settings and verification of dielectric insulation resistance.
- Verification and recording of heater supply voltage and heater circuit current readings.
- IR camera checks for cold sections (heat sinks) and heater circuit current readings.

### Maintenance and Troubleshooting

- Thermon has some of the best service technicians in the industry, with many years of troubleshooting and repair experience. It takes years of practice to become proficient at splicing and finding failures, and with our expertise we are able to complete the job quicker than workers that are new to the process. Customers benefit by having a warranty on all work completed, complete documentation as well as fast, reliable service at the best possible price.
- Contracts - Thermon offers special pricing on service contracts. We work closely with customers to design a contract that meets their heat tracing needs.
- Rope access is available.





## THERMON PRODUCT TRAINING AND SERVICES

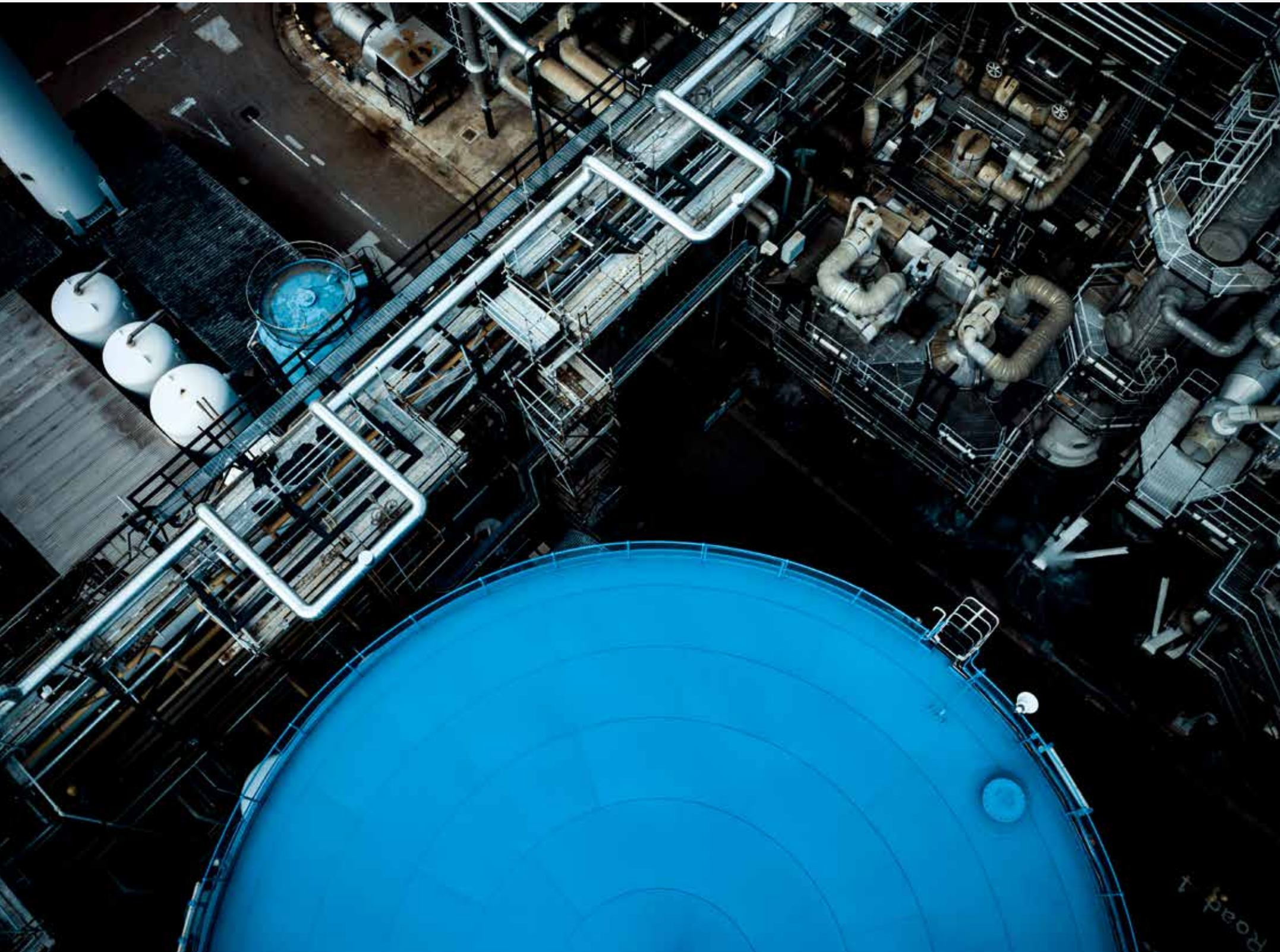

### Panel Maintenance Program

- The panel Maintenance program is a good offering for late spring, summer, and early fall.
- Ensure your panels are in perfect operating condition for the winter season.
- Custom-built programs can include full health checks of all your EHT and operating systems, as well as alarm management.

### On-Site Technicians Providing Service and Ongoing Support

- Installation Inspections—complete testing and inspections, with documentation, for peace of mind that your system is installed correctly.
- Inspection/Supervision for all work on EHT system changes—ensure factory warranties are kept intact by having Thermon oversee or inspect any work completed on its products.
- Ongoing on-site support for small or large projects assisting with all aspects of your EHT systems, from splicing to inspections and QA/QC.
- Verification of set points for customer program data sheets and logging of any discrepancies.
- Re-torquing of all terminal blocks and related hardware.
- IR camera inspection and logging of any overheating relays.
- Panel out megger and resistance testing and logging of each circuit in the panels.
- Logging of displayed alarms.
- Recommendations and quoting for repair of identified issues.



# SAFETY

Safety is a core value at Thermon. We operate in a manner that helps protect our employees, contractors, customers and the communities where we operate. Our approach to safety includes identifying possible risks, implementing measures to prevent potential incidents, and educating employees about unsafe behaviors. Our Incident Management System (Progress) has established a set of worldwide expectations for addressing risks and serves as the foundation for communicating leading and lagging indicators.

Thermon(s) 2020 total recordable workforce (employees and contractors) incident rate per 200,000 work hours was 0.20, similar to our performance in 2019. When compared to our NAICs industry workforce benchmark of 2.3, Thermon continues to be among the industry leaders in safety performance.

**THERMON**  
**OFFICES WORLDWIDE**

Thermon's global footprint with local presence. Thermon serves the global Energy, Power Generation, and Chemical markets to provide innovative solutions for industrial heating applications by deeply understanding our customers' needs.



- HEADQUARTERS
- PRODUCTION PLANT
- SALES AND ENGINEERING
- TURNKEY/CONSTRUCTION SERVICES

UNITED STATES | CANADA | MEXICO | NETHERLANDS | UNITED KINGDOM | FRANCE | SPAIN  
GERMANY | RUSSIA | AUSTRALIA | MALAYSIA | CHINA | INDIA | JAPAN | SOUTH | KOREA | BAHRAIN

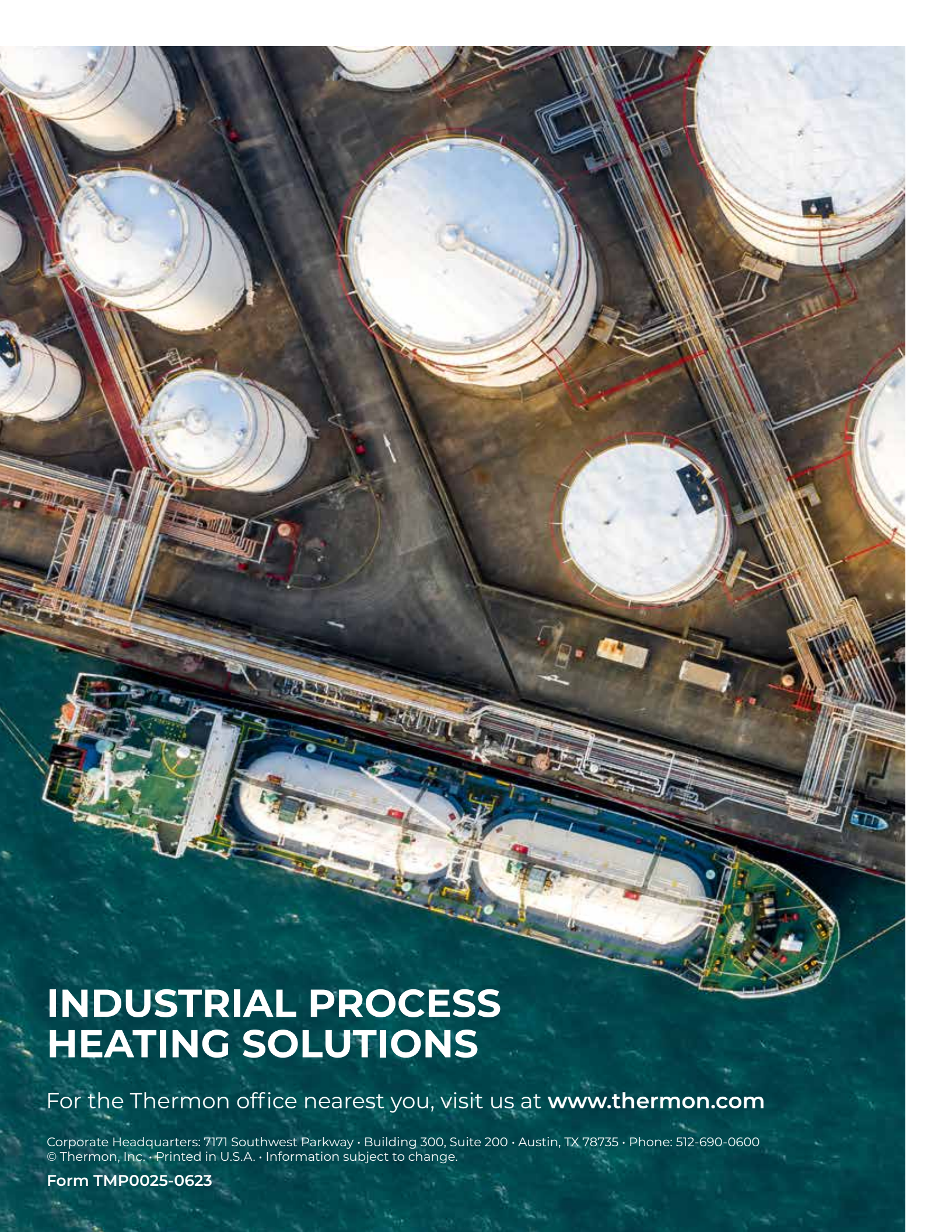

# INDUSTRIAL PROCESS HEATING SOLUTIONS

For the Thermon office nearest you, visit us at [www.thermon.com](http://www.thermon.com)

Corporate Headquarters: 7171 Southwest Parkway • Building 300, Suite 200 • Austin, TX 78735 • Phone: 512-690-0600  
© Thermon, Inc. • Printed in U.S.A. • Information subject to change.

Form TMP0025-0623